

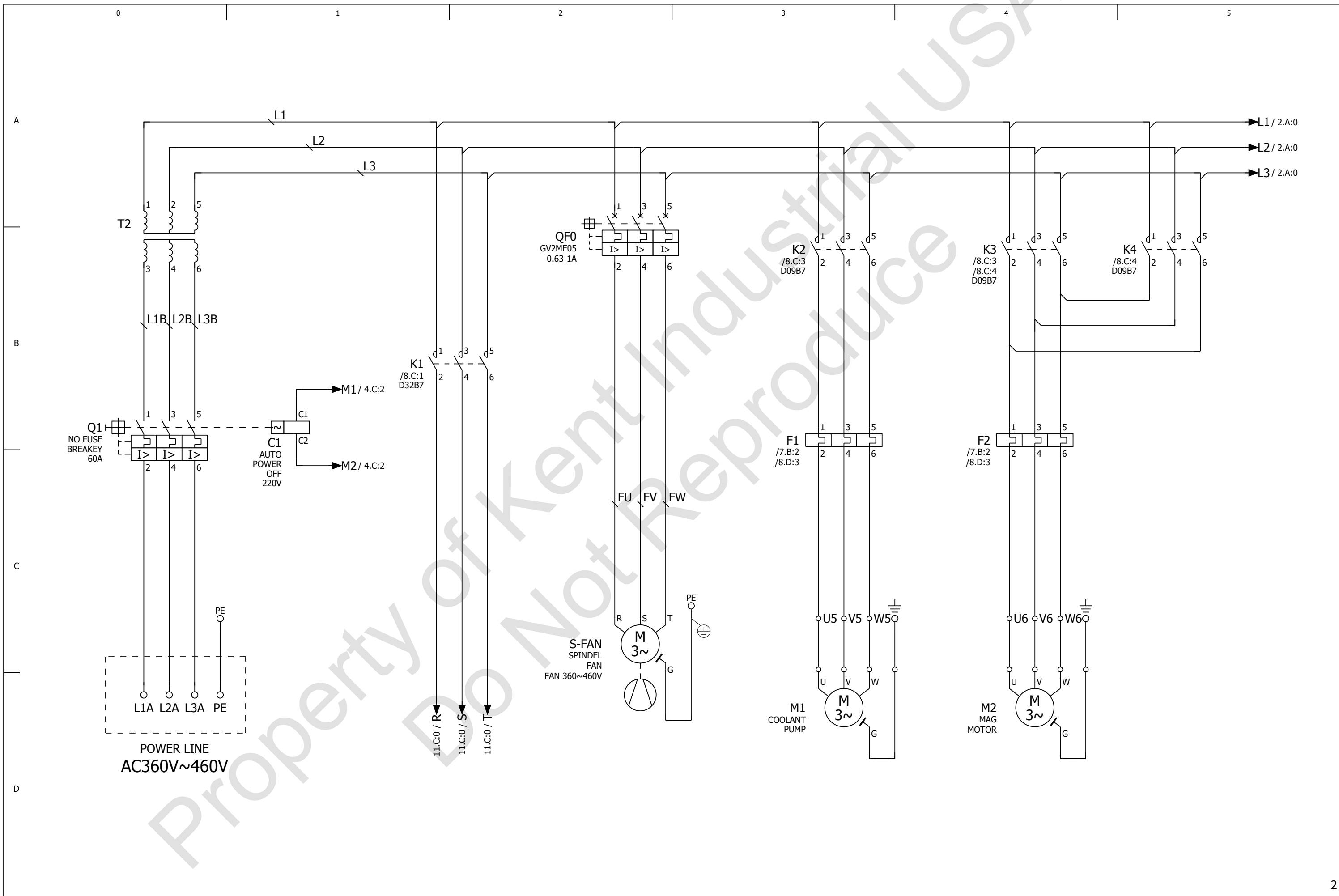

Kent USA TW-320MCO Electrical Manual

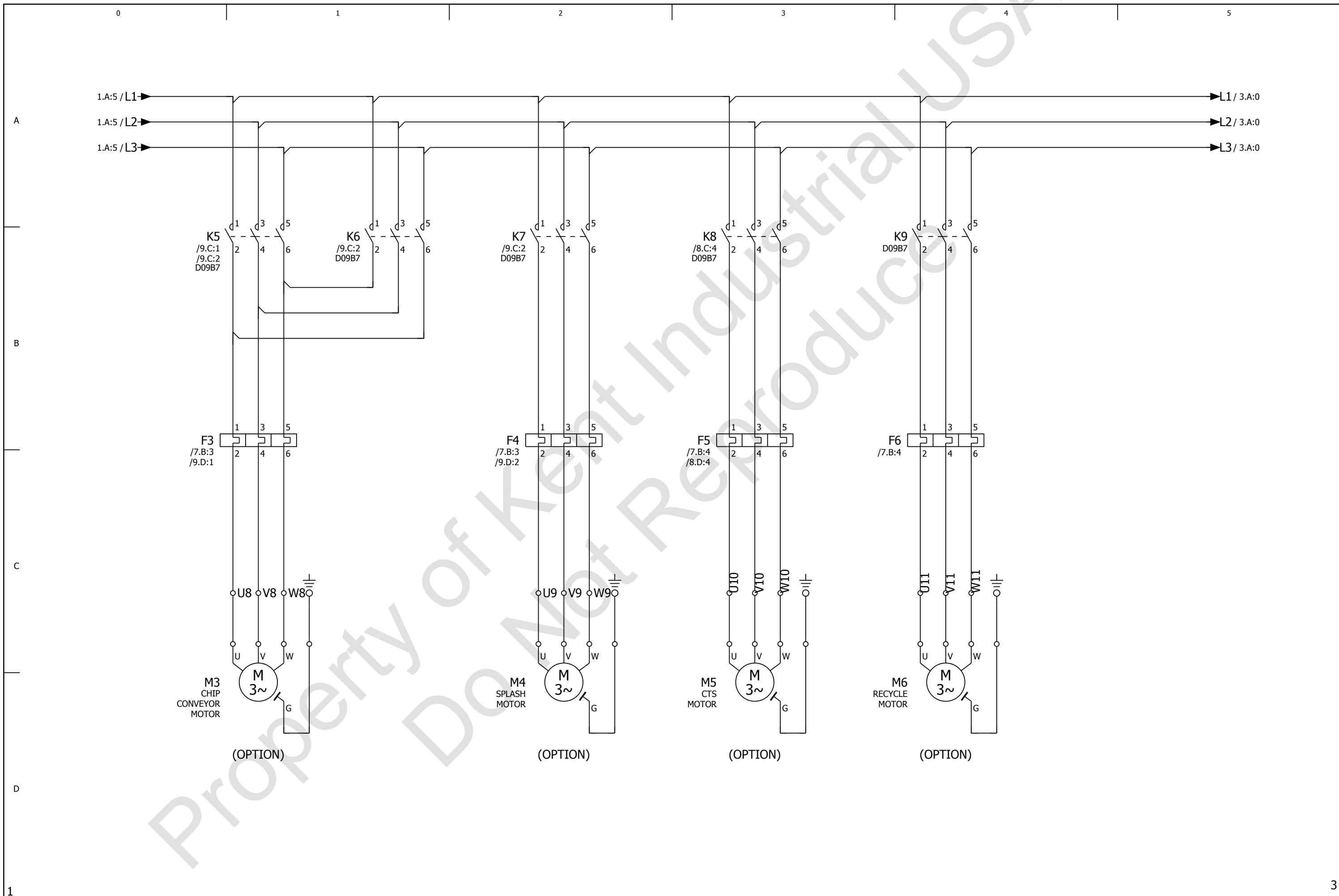

Machine Model	Designaion Standard	Title Paeg	BARON-MAX	=
	FAGOR 8055I CNC	POWER-1		+
		Date: 2012/9/21	Ref:	Page 1
				Page 30



Machine Model	Designaion Standard	Title Paeg	BARON-MAX	=
	FAGOR 8055I CNC	POWER-2		+
Date: 2012/9/21			Ref:	Page 2
				Page 30

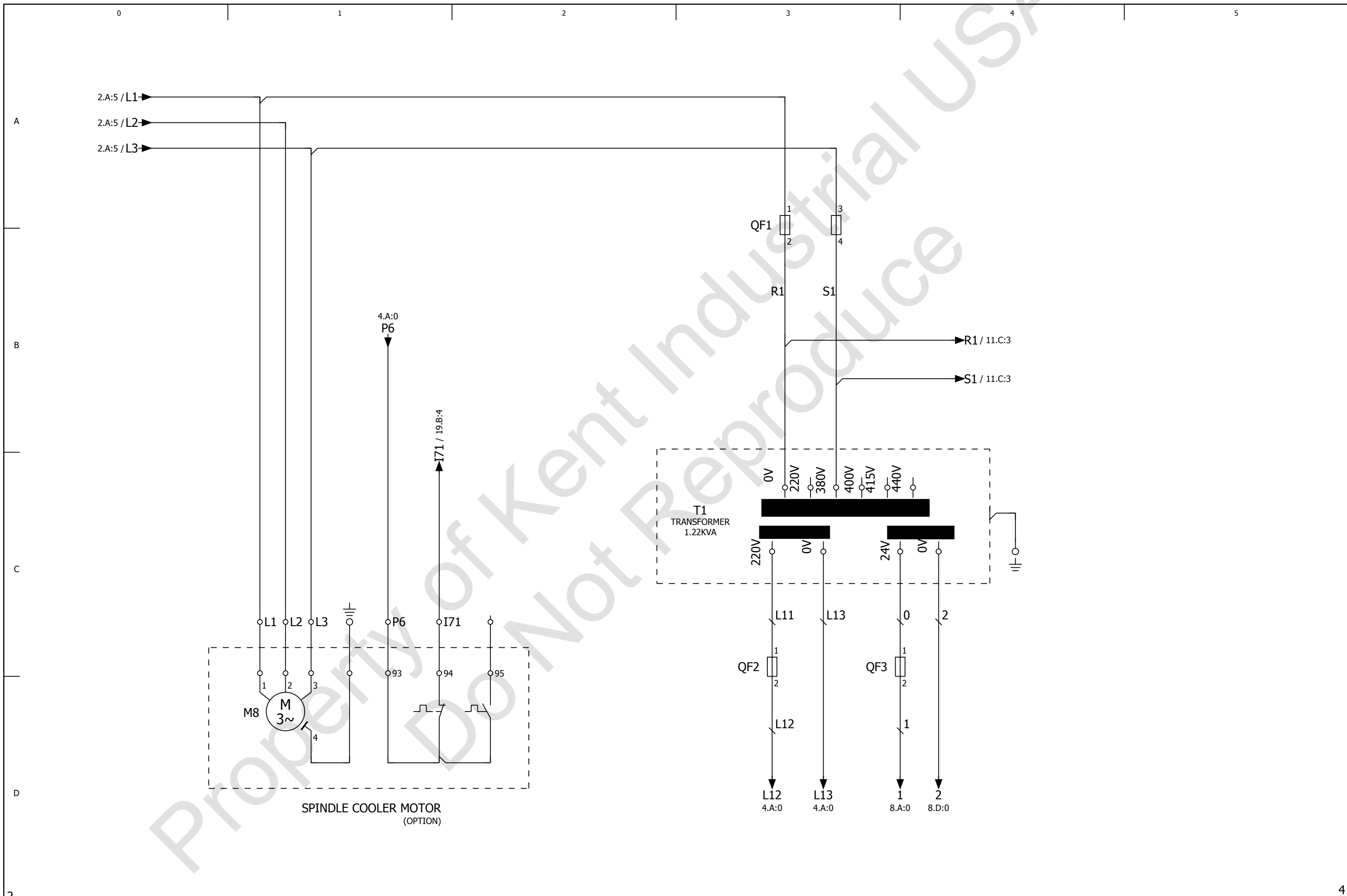

Machine Model	Designaion Standard	Title Paeg	BARON-MAX	=
	FAGOR 8055I CNC	POWER-3		+
		Date: 2012/9/21	Ref:	Page 3
				Page 30

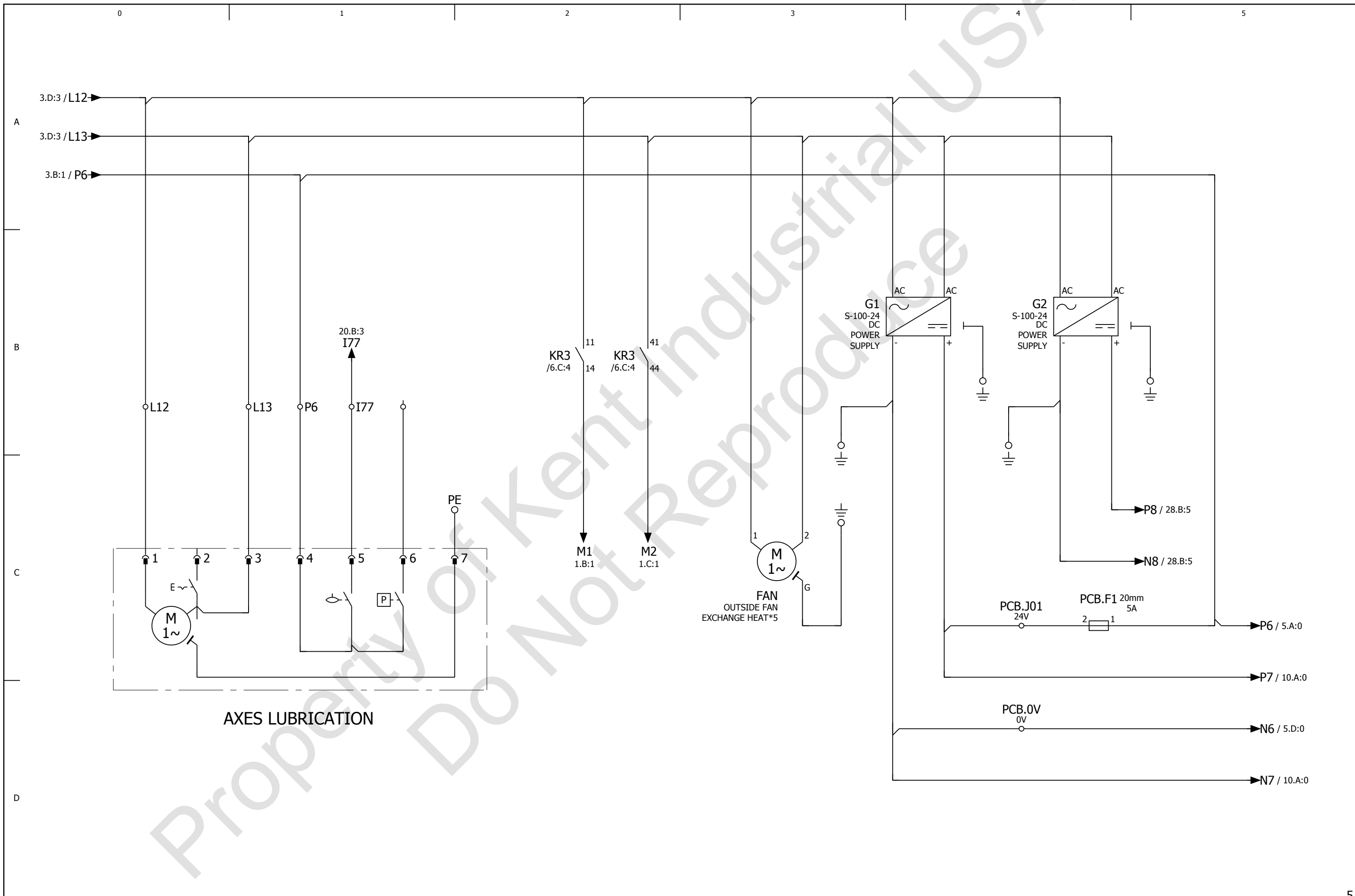

AXES LUBRICATION

Machine Model	Designaion Standard	Title Paeg	BARON-MAX	=
FAGOR 8055I CNC		POWER_AC220V-1		+
		Date: 2012/9/21	Ref:	
				Page 4
				Page 30

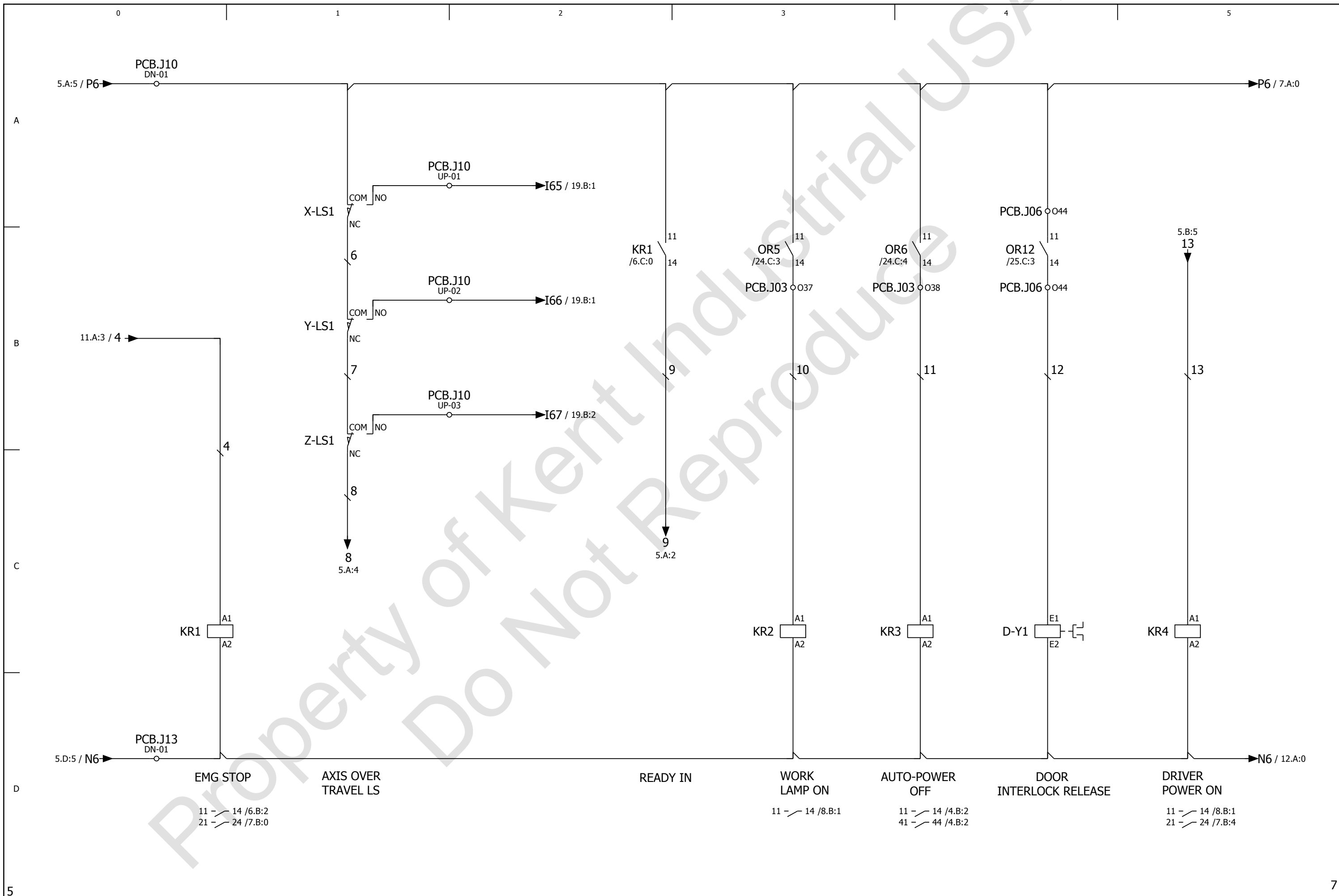

Machine Model	Designaion Standard	Title Paeg	BARON-MAX	=
	FAGOR 8055I CNC	CONTROL_DC24V-1		+
		Date: 2012/9/21	Ref:	Page 6
				Page 30

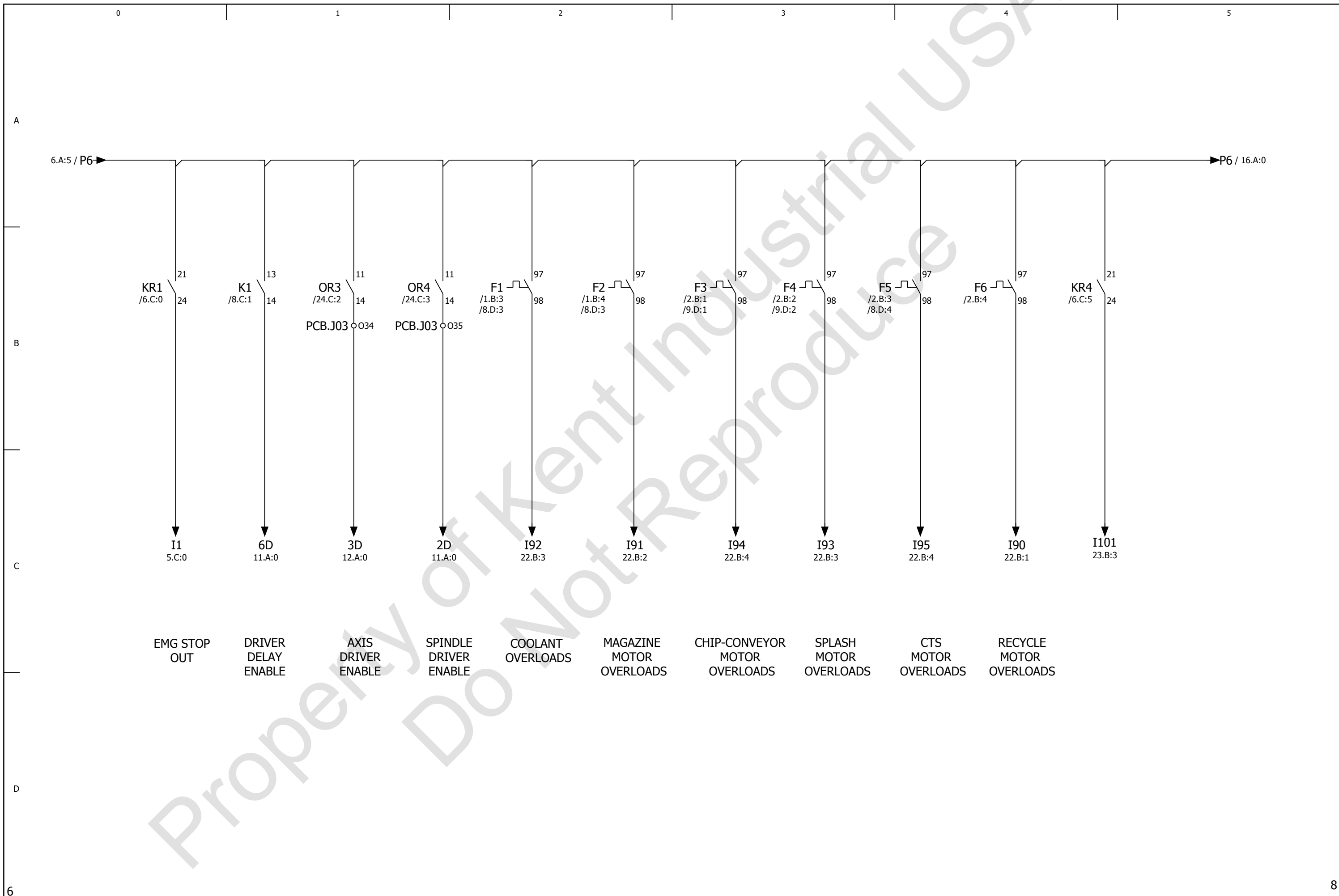

Machine Model	Designaion Standard	Title Paeg	BARON-MAX	=
	FAGOR 8055I CNC	CONTROL_DC24V-2		+
		Date: 2012/9/21	Ref:	Page 7
				Page 30

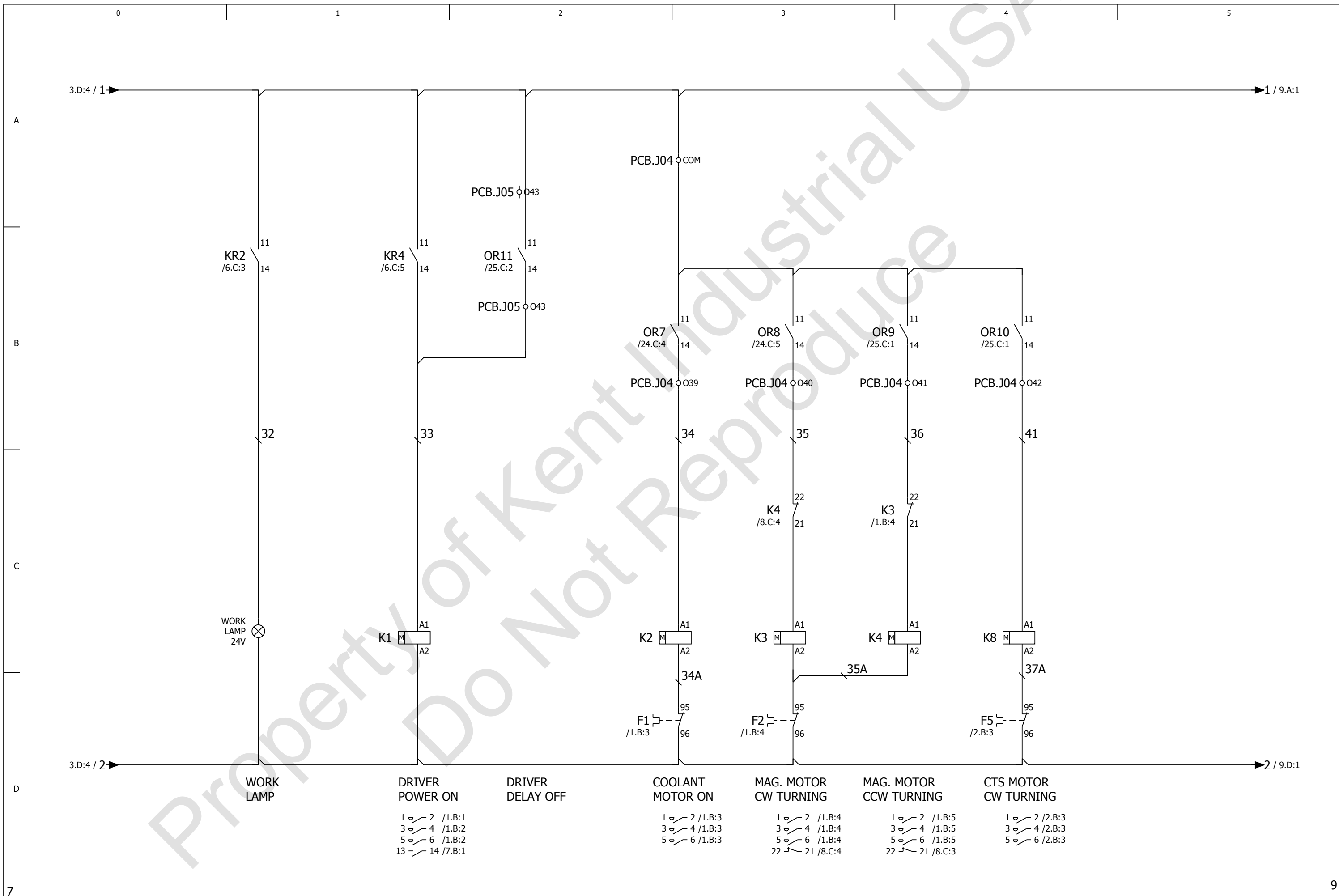

1 2 /1.B:1
 3 4 /1.B:2
 5 6 /1.B:2
 13 14 /7.B:1

1 2 /1.B:3
 3 4 /1.B:3
 5 6 /1.B:3

1 2 /1.B:4
 3 4 /1.B:4
 5 6 /1.B:4
 22 21 /8.C:4

1 2 /1.B:5
 3 4 /1.B:5
 5 6 /1.B:5
 22 21 /8.C:3

1 2 /2.B:3
 3 4 /2.B:3
 5 6 /2.B:3

Machine Model	Designaion Standard	Title Paeg	BARON-MAX	=
	FAGOR 8055I CNC	CONTROL_AC24V-1		+
		Date: 2012/9/21	Ref:	
				Page 8
				Page 30

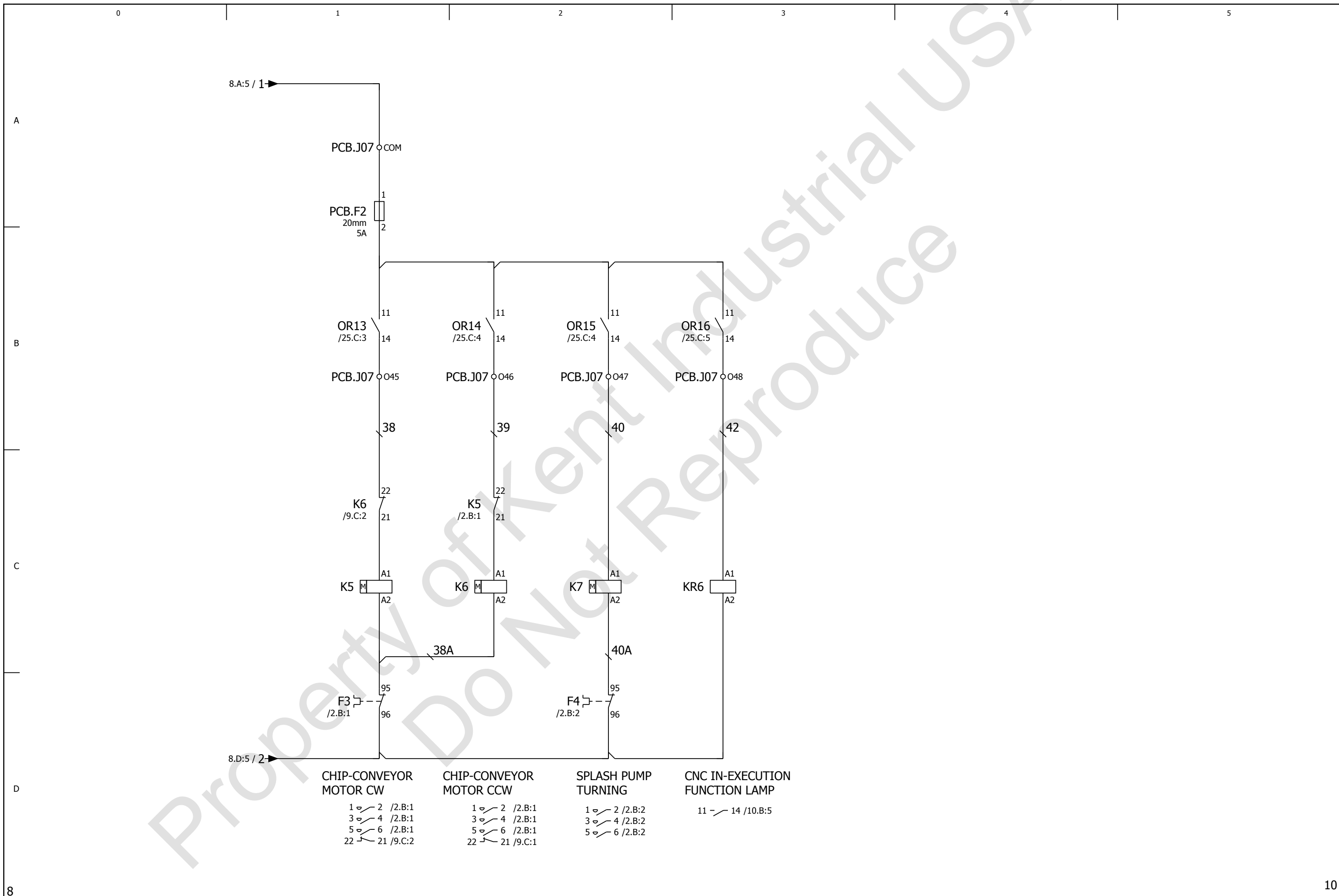

Machine Model	Designaion Standard	Title Paeg	BARON-MAX	=
	FAGOR 8055I CNC	CONTROL_AC24V-2		+
		Date: 2012/9/21	Ref:	Page 9
				Page 30

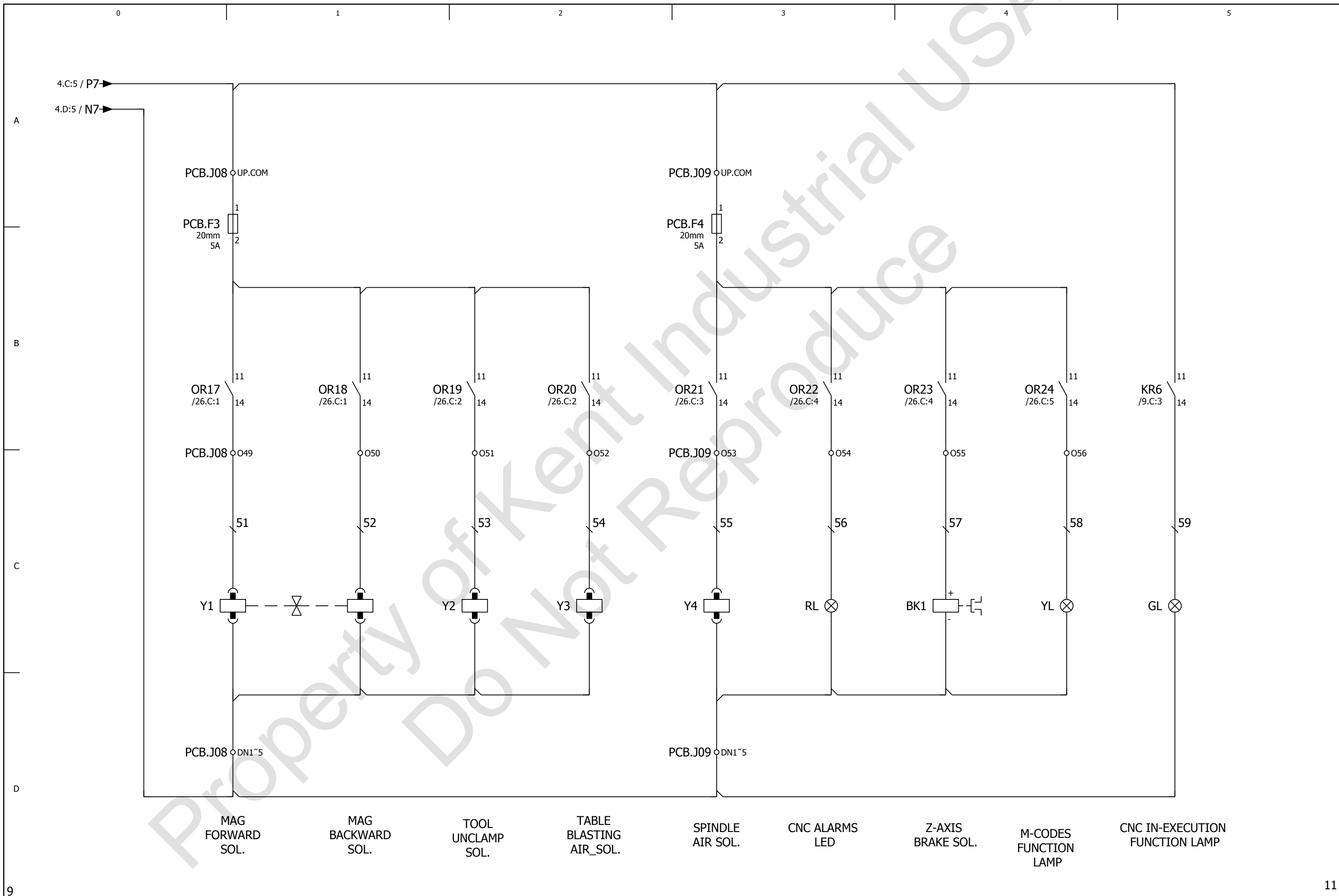

MAG FORWARD SOL.

MAG BACKWARD SOL.

TOOL UNCLAMP SOL.

TABLE BLASTING AIR_SOL.

SPINDLE AIR SOL.

CNC ALARMS LED

Z-AXIS BRAKE SOL.

M-CODES FUNCTION LAMP

CNC IN-EXECUTION FUNCTION LAMP

9

11

Machine Model	Designaion Standard	Title Paeg	BARON-MAX	=
	FAGOR 8055I CNC	CONTROL_SOL-1		+
		Date: 2012/4/26	Ref:	
				Page 10
				Page 30

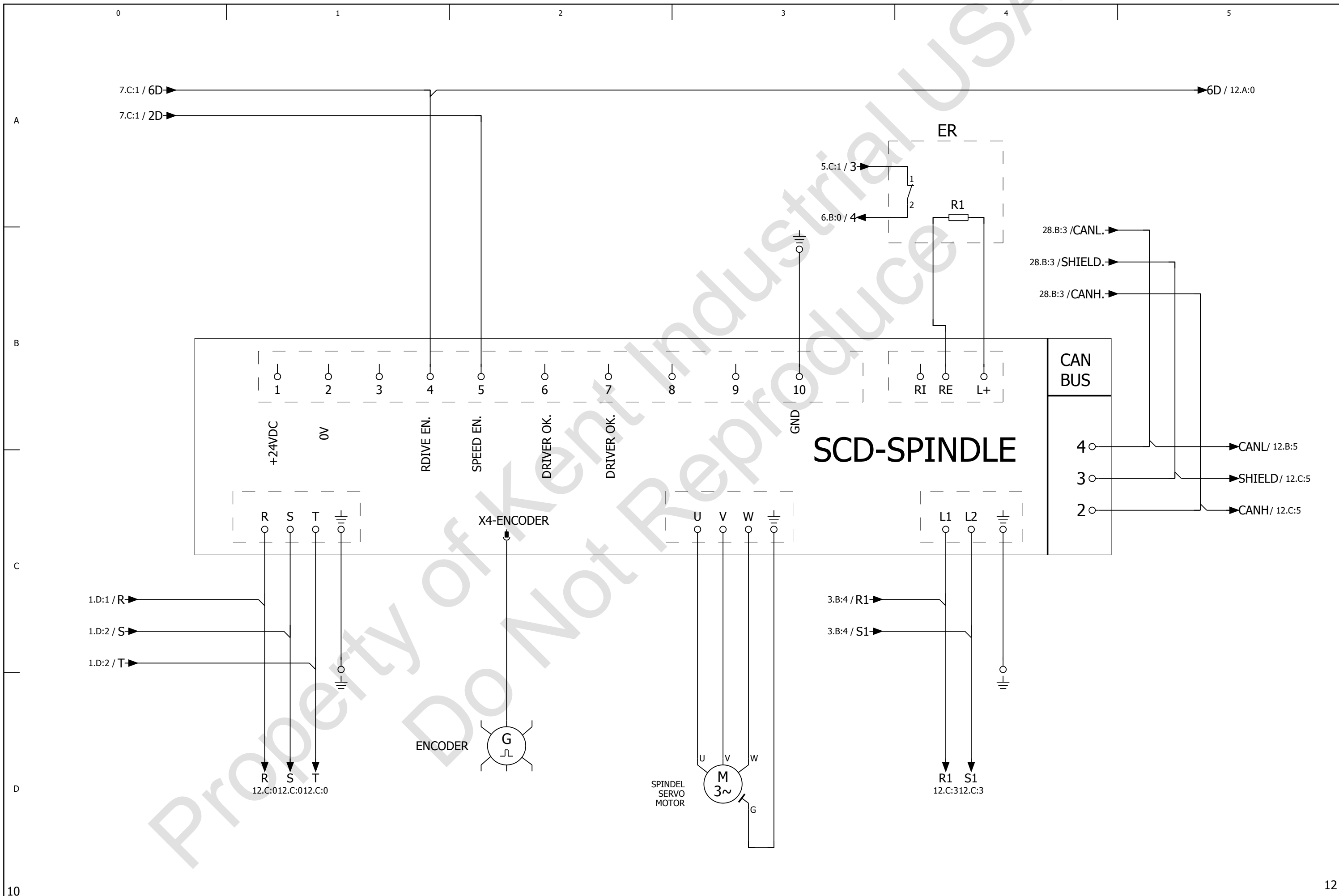

Machine Model	Designaion Standard	Title Paeg	BARON-MAX	=
FAGOR 8055I CNC		SERVO DRIVER-SCD-S		+
		Date: 2012/9/21	Ref:	
				Page 11
				Page 30

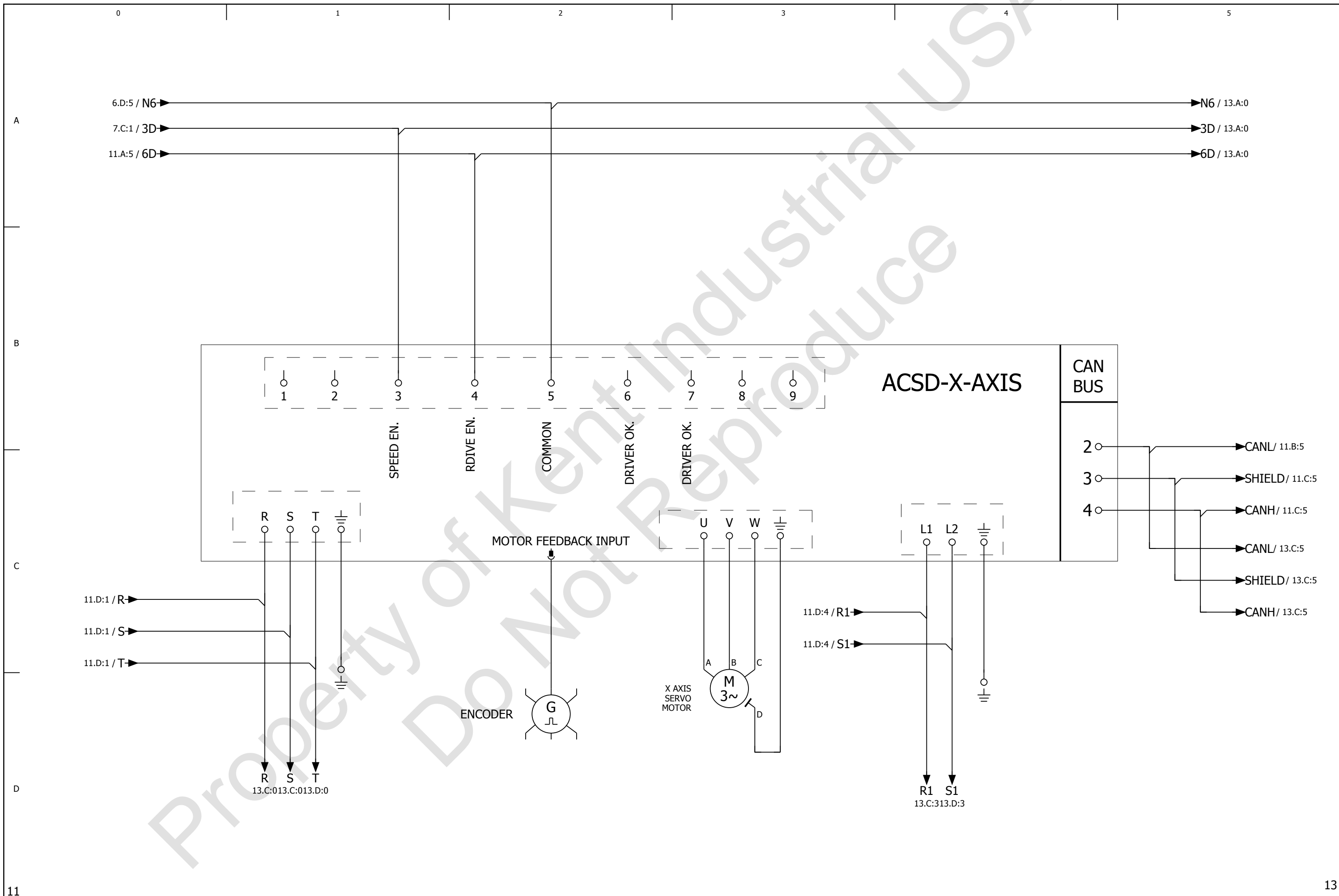

Machine Model	Designaion Standard	Title Paeg	BARON-MAX		=
	FAGOR 8055I CNC	SERVO-DRIVER-ACSD-X	Date: 2012/9/21	Ref:	+
					Page 12
					Page 30

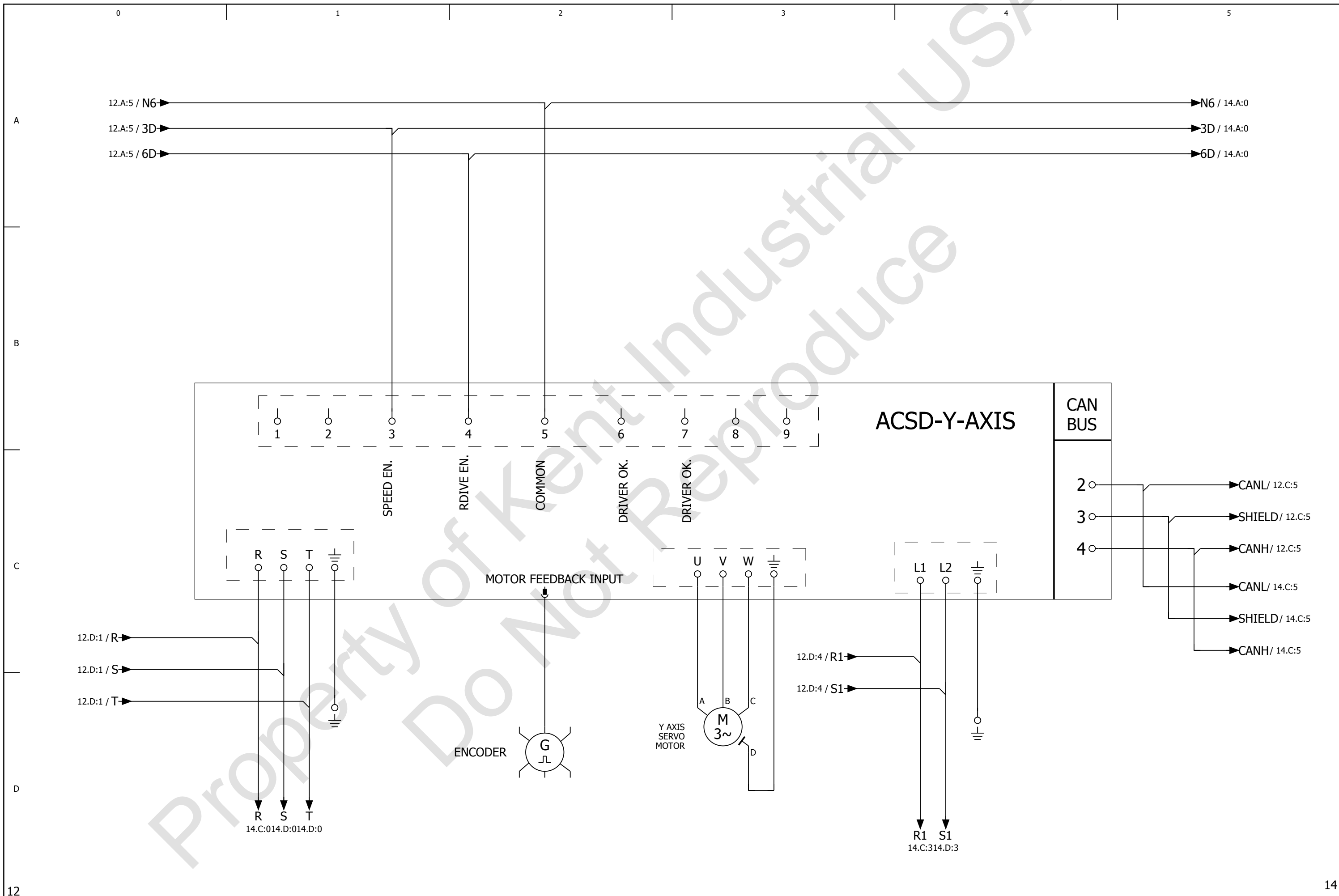

Machine Model	Designaion Standard	Title Paeg	BARON-MAX		=
	FAGOR 8055I CNC	SERVO-DRIVER-ACSD-Y			+
			Date: 2012/9/21	Ref:	Page 13
					Page 30

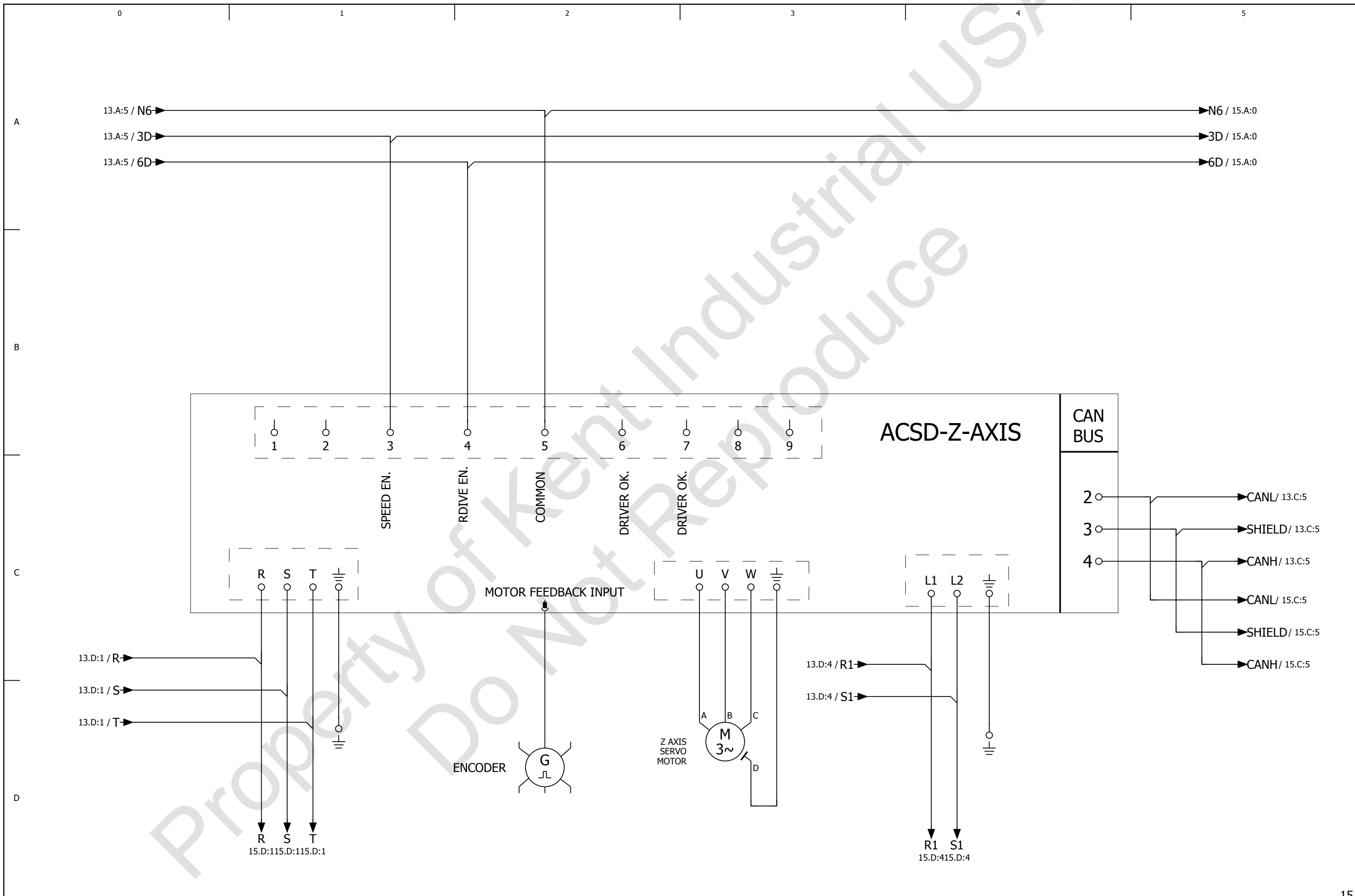

Machine Model	Designaion Standard	Title Paeg	BARON-MAX	
FAGOR 8055I CNC	SERVO-DRIVER-ACSD-Z		Date: 2012/9/21	Ref:
				Page 14
				Page 30

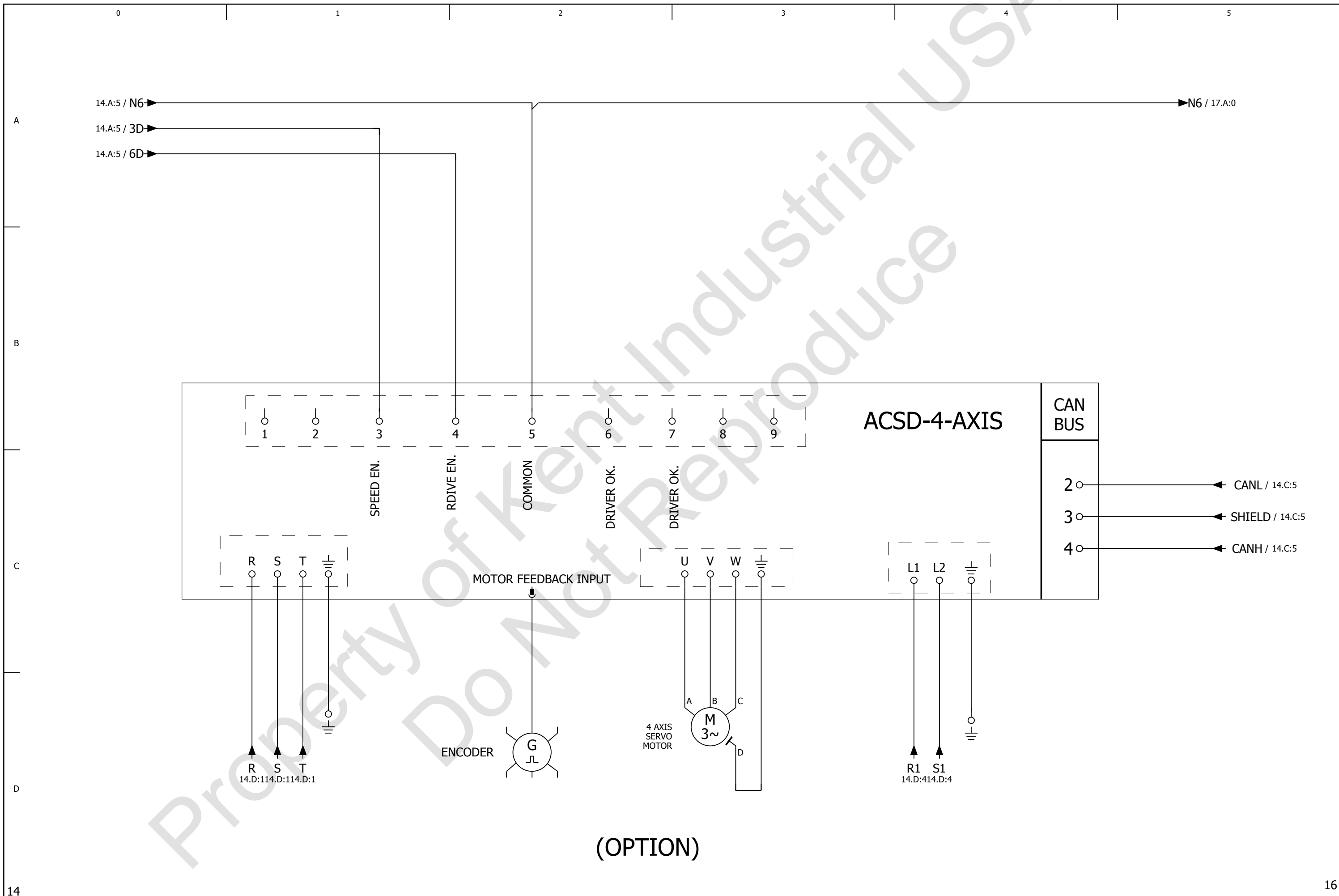

(OPTION)

Machine Model	Designaion Standard	Title Paeg	BARON-MAX	=
	FAGOR 8055I CNC	SERVO-DRIVER-ACSD-4		+
		Date: 2012/9/21	Ref:	Page 15
				Page 30

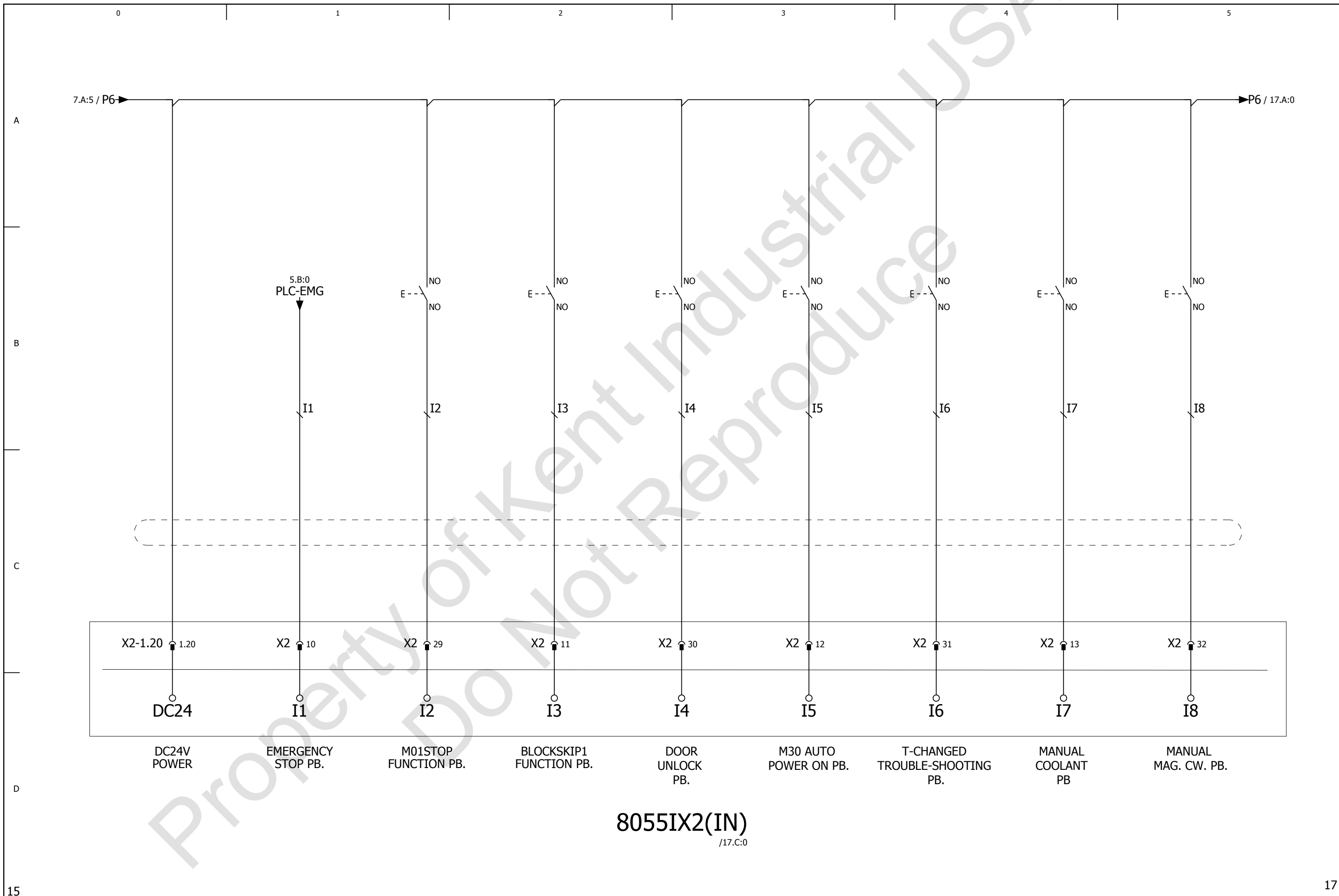

8055IX2(IN)
/17.C:0

Machine Model	Designaion Standard	Title Paeg	BARON-MAX	=
	FAGOR 8055I CNC	I/O UNIT-X2_IN-1		+
		Date: 2012/9/21	Ref:	Page 16
				Page 30

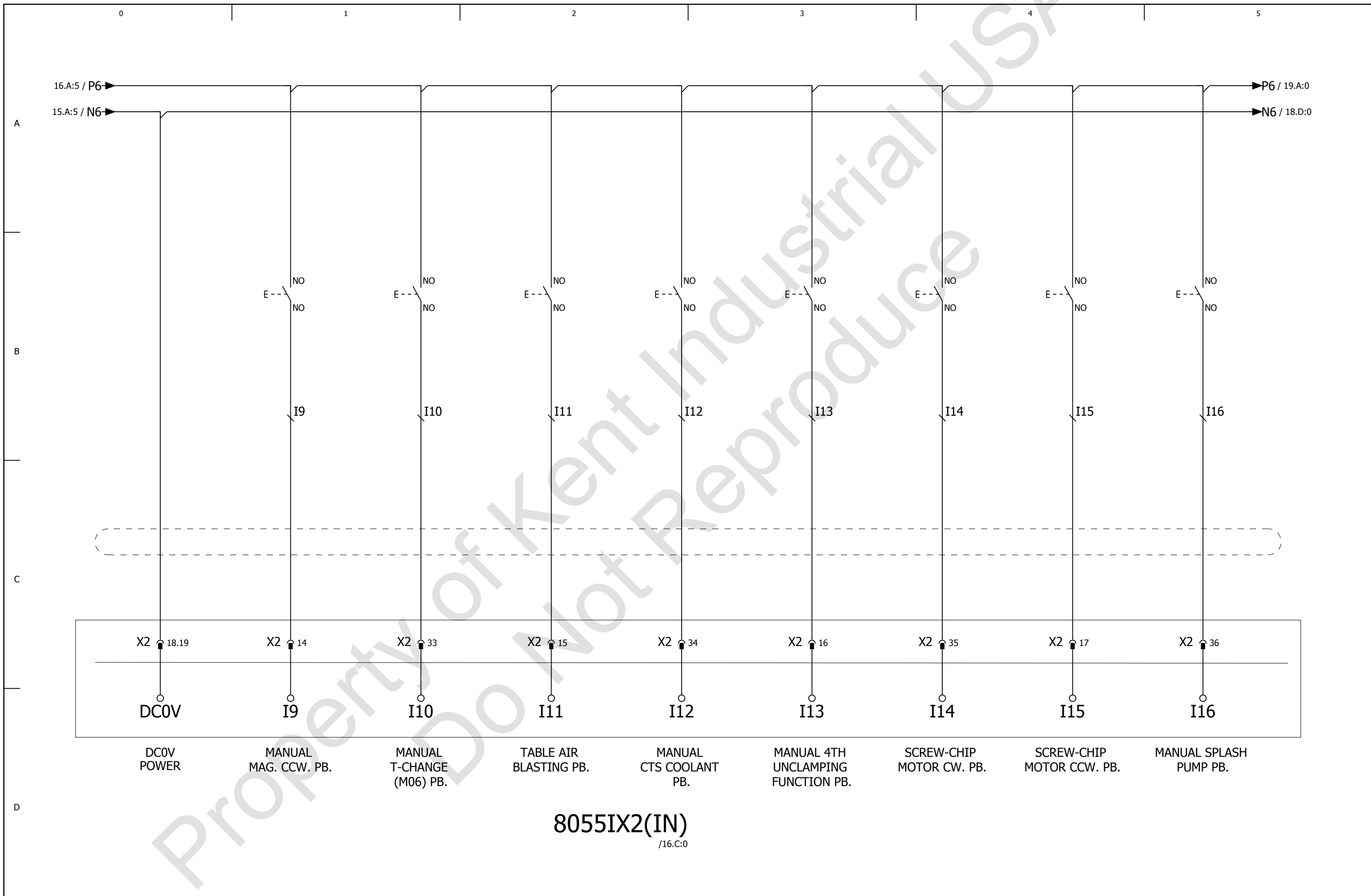

8055IX2(IN)
/16.C:0

Machine Model	Designaion Standard	Title Paeg	BARON-MAX	=
	FAGOR 8055I CNC	I/O UNIT-X2_IN-2		+
		Date: 2012/9/21	Ref:	Page 17
				Page 30

8055IX2(OUT)

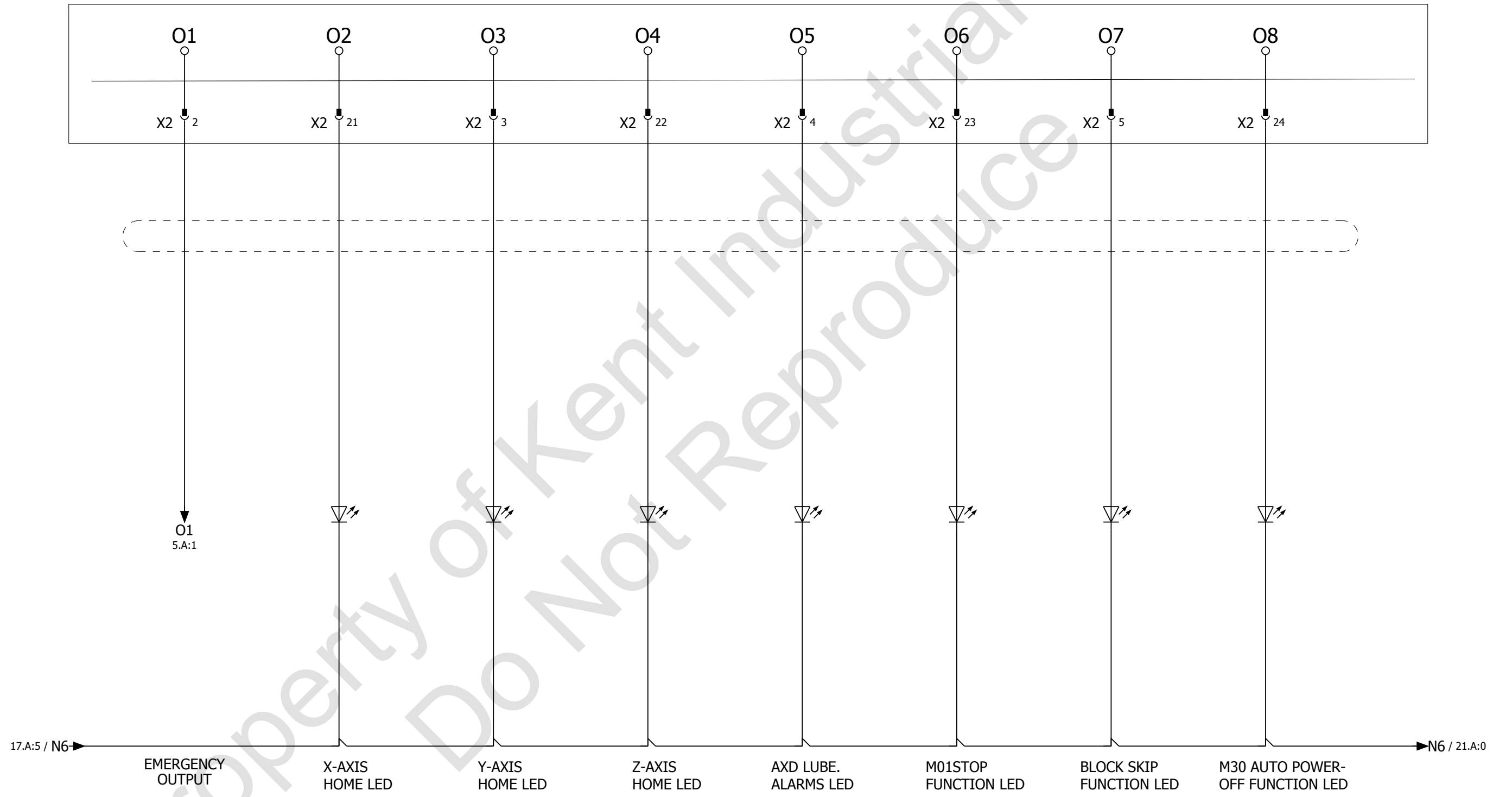

Property of Kent Industrial USA
Do Not Reproduce

Machine Model	Designaion Standard	Title Paeg	BARON-MAX	=
	FAGOR 8055I CNC	I/O UNIT-X2_OUT		+
		Date: 2012/4/26	Ref:	Page 18
				Page 30

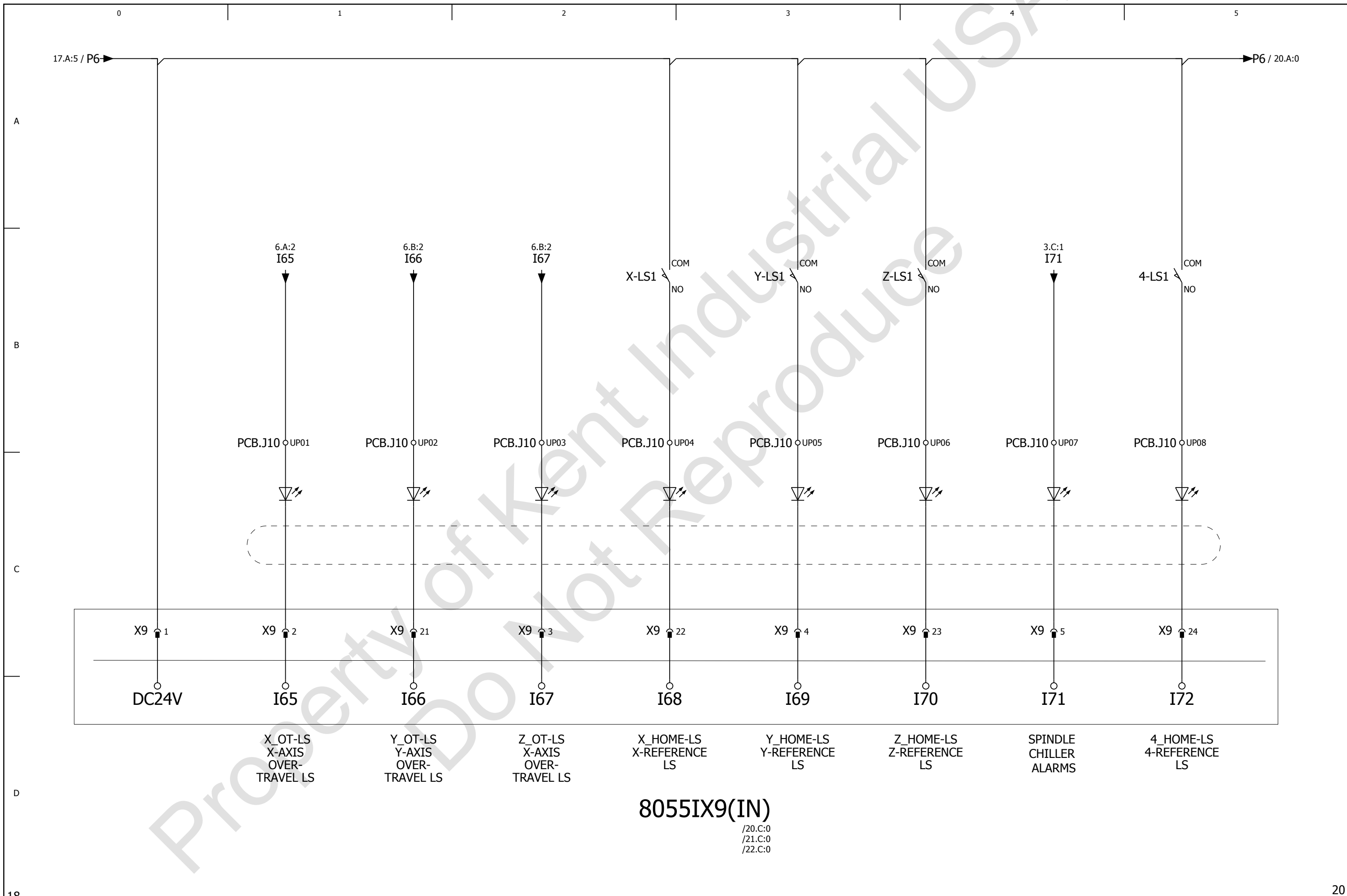

8055IX9(IN)

/20.C:0
/21.C:0
/22.C:0

Machine Model	Designaion Standard	Title Paeg	BARON-MAX	=
FAGOR 8055I CNC		I/O UNIT-X9_IN-1		+
		Date: 2012/9/21	Ref:	Page 19
				Page 30

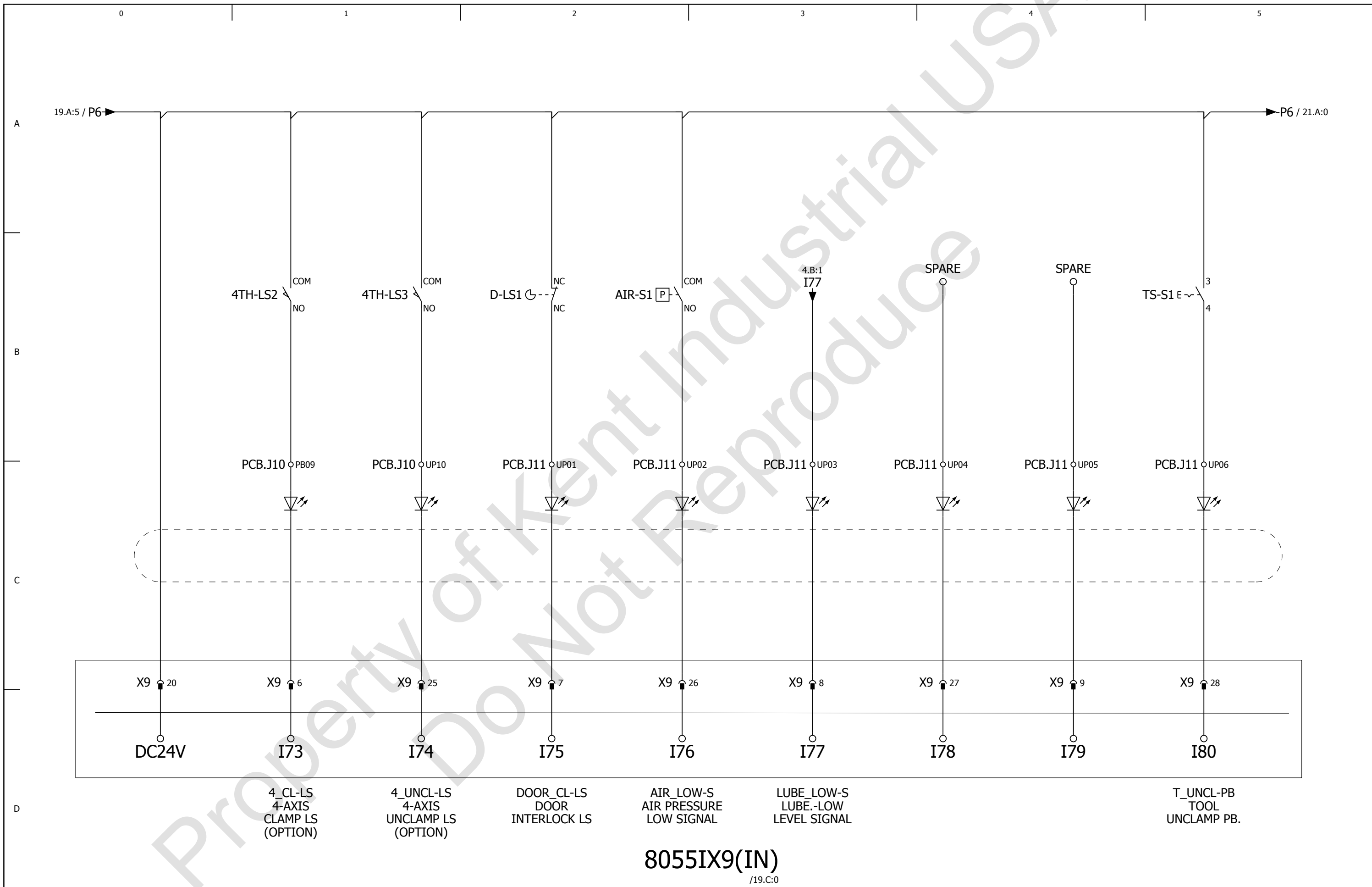

Machine Model	Designaion Standard	Title Paeg	BARON-MAX	=
	FAGOR 8055I CNC	I/O UNIT-X9_IN-2		+
			Date: 2012/9/21	Ref:
				Page 20
				Page 30

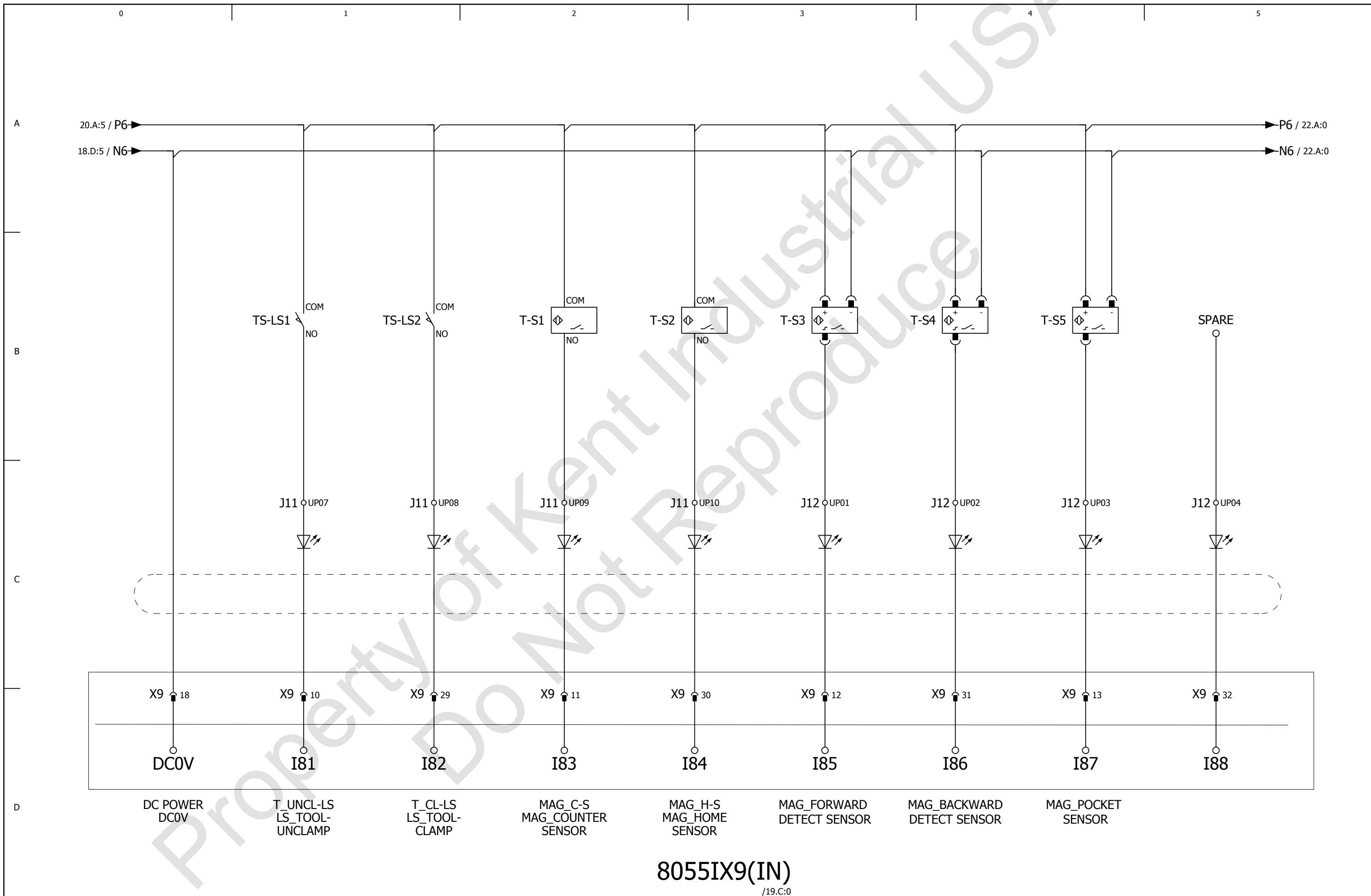

8055IX9(IN)
/19.C:0

Machine Model	Designaion Standard	Title Paeg	BARON-MAX	=
FAGOR 8055I CNC		I/O UNIT-X9_IN-3		+
		Date: 2012/9/21	Ref:	Page 21
				Page 30

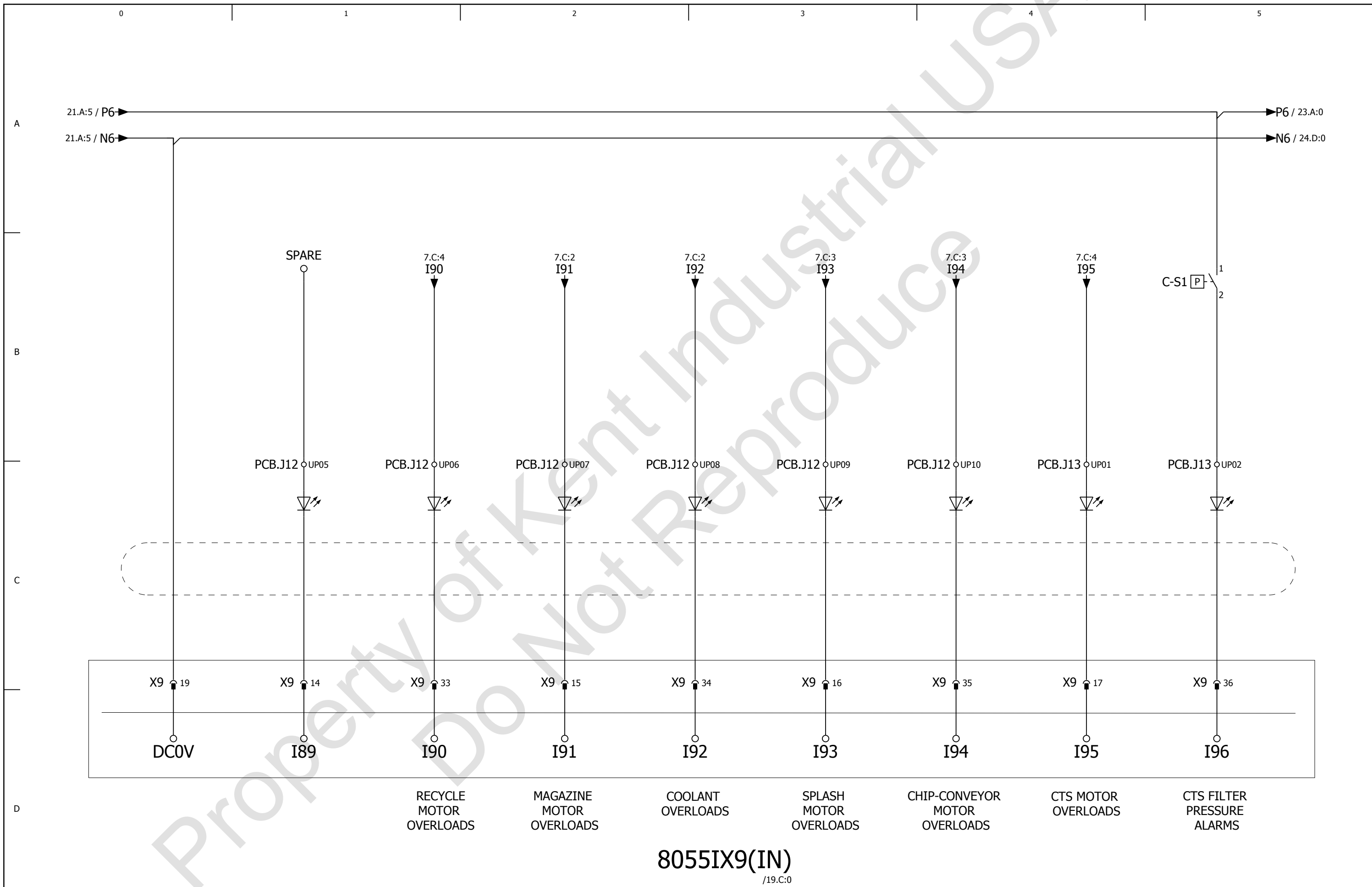

8055IX9(IN)
/19.C:0

Machine Model	Designaion Standard	Title Paeg	BARON-MAX	=
FAGOR 8055I CNC		I/O UNIT-X9_IN-4		+
		Date: 2012/9/21	Ref:	
				Page 22
				Page 30

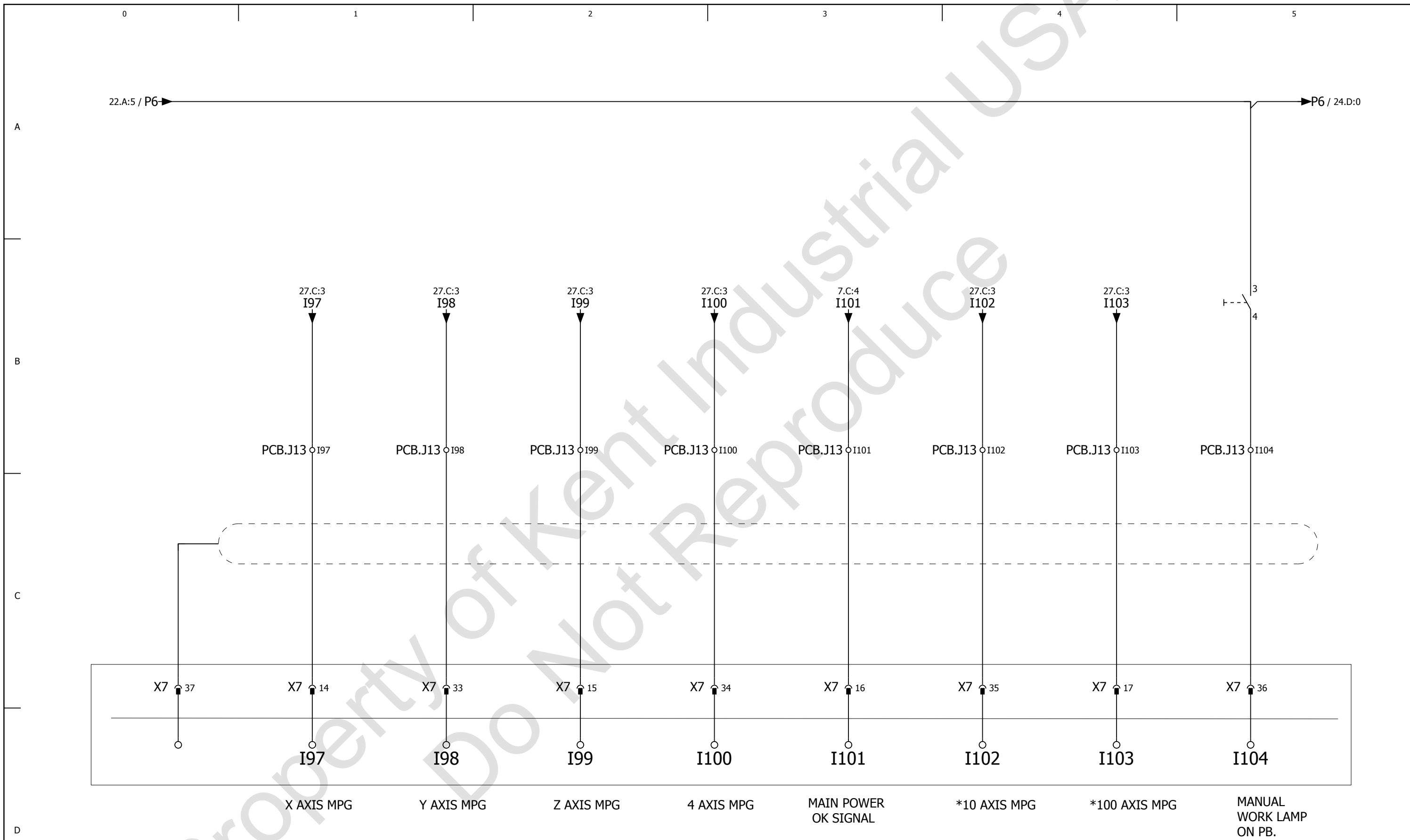

8055IX7(IN)

Machine Model	Designaion Standard	Title Paeg	BARON-MAX	=
	FAGOR 8055I CNC	I/O UNIT-X7-IN		+
		Date: 2012/9/21	Ref:	Page 23
				Page 30

8055IX7(OUT)

/25.A:0
/26.A:0

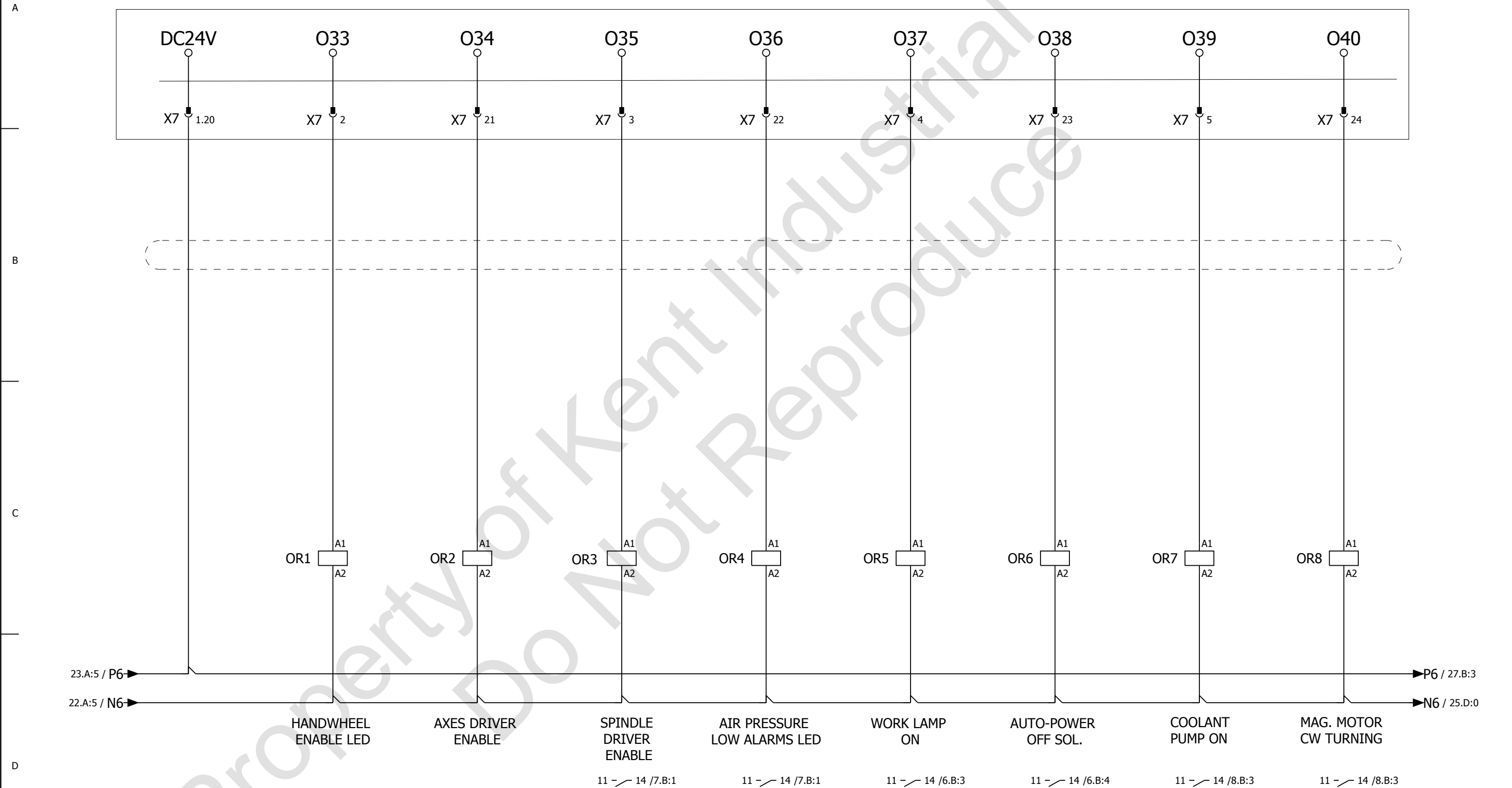

Machine Model	Designaion Standard	Title Paeg	BARON-MAX	=
FAGOR 8055I CNC		I/O-UNIT-X7_OUT-1		+
		Date: 2012/9/21	Ref:	
				Page 24
				Page 30

8055IX7(OUT)

/24.A:0

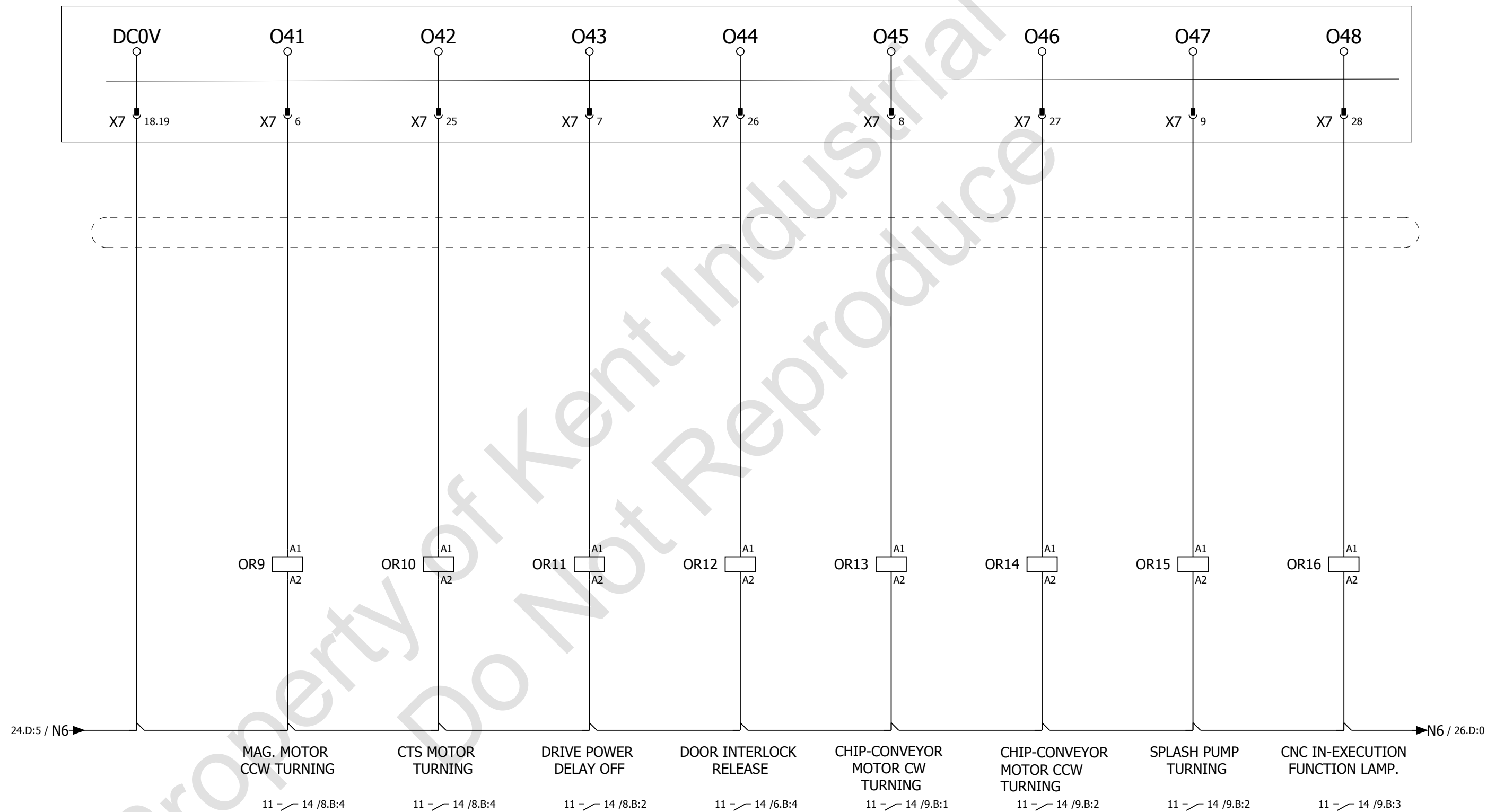

Machine Model	Designaion Standard	Title Paeg	BARON-MAX
FAGOR 8055I CNC	I/O-UNIT-X7_OUT-2	Date: 2012/4/26	Ref:
			= + Page 25 Page 30

8055IX7(OUT)

/24.A:0

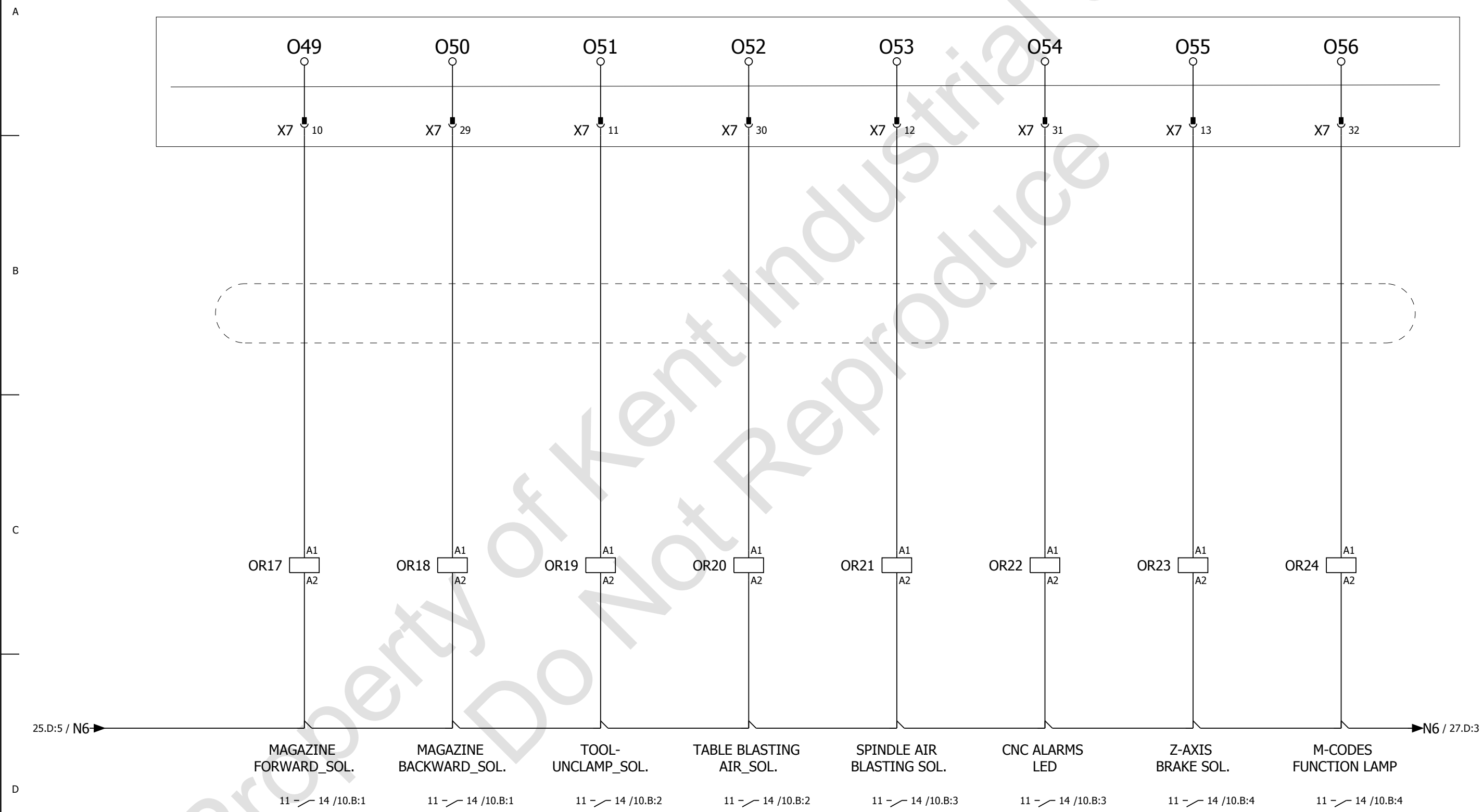

Machine Model	Designaion Standard	Title Paeg	BARON-MAX
FAGOR 8055I CNC	I/O-UNIT-X7_OUT-3	Date: 2012/4/26	Ref:
			Page 26 Page 30

A
B
C
D

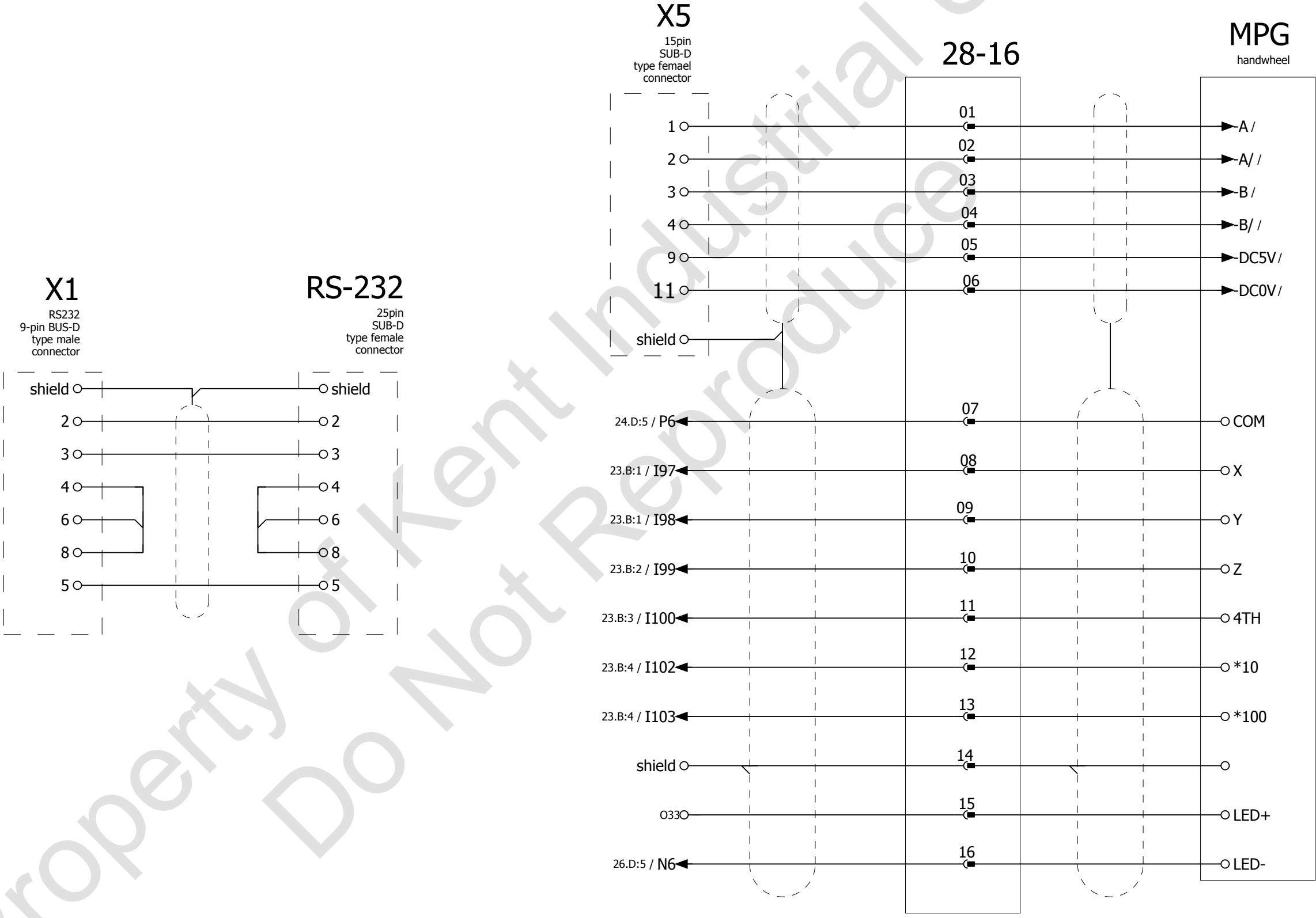

Machine Model	Designaion Standard	Title Paeg	BARON-MAX	=
	FAGOR 8055I CNC	MPG		+
		Date: 2012/9/21	Ref:	
				Page 27
				Page 30

8055I-CNC

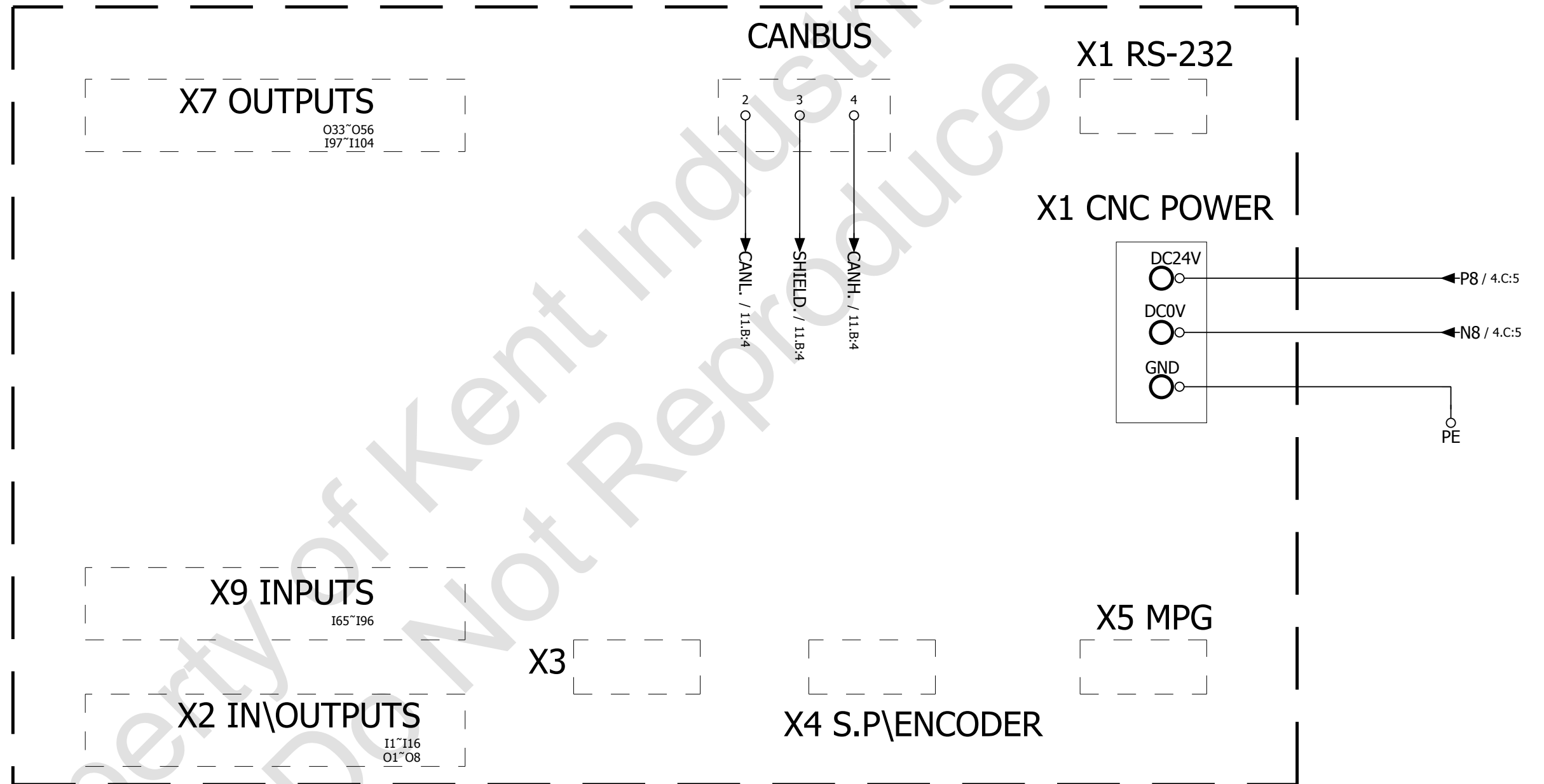

Machine Model	Designaion Standard	Title Paeg	BARON-MAX	=
	FAGOR 8055I CNC	CNC-CONNECTOR-1		+
		Date: 2012/4/26	Ref:	Page 28
				Page 30

0

1

2

3

4

5

A

B

C

D

3102A-28-11S
FEMALE CONNECTOR

4-AXIS MOTOR
OUTPUT CONNECTOR

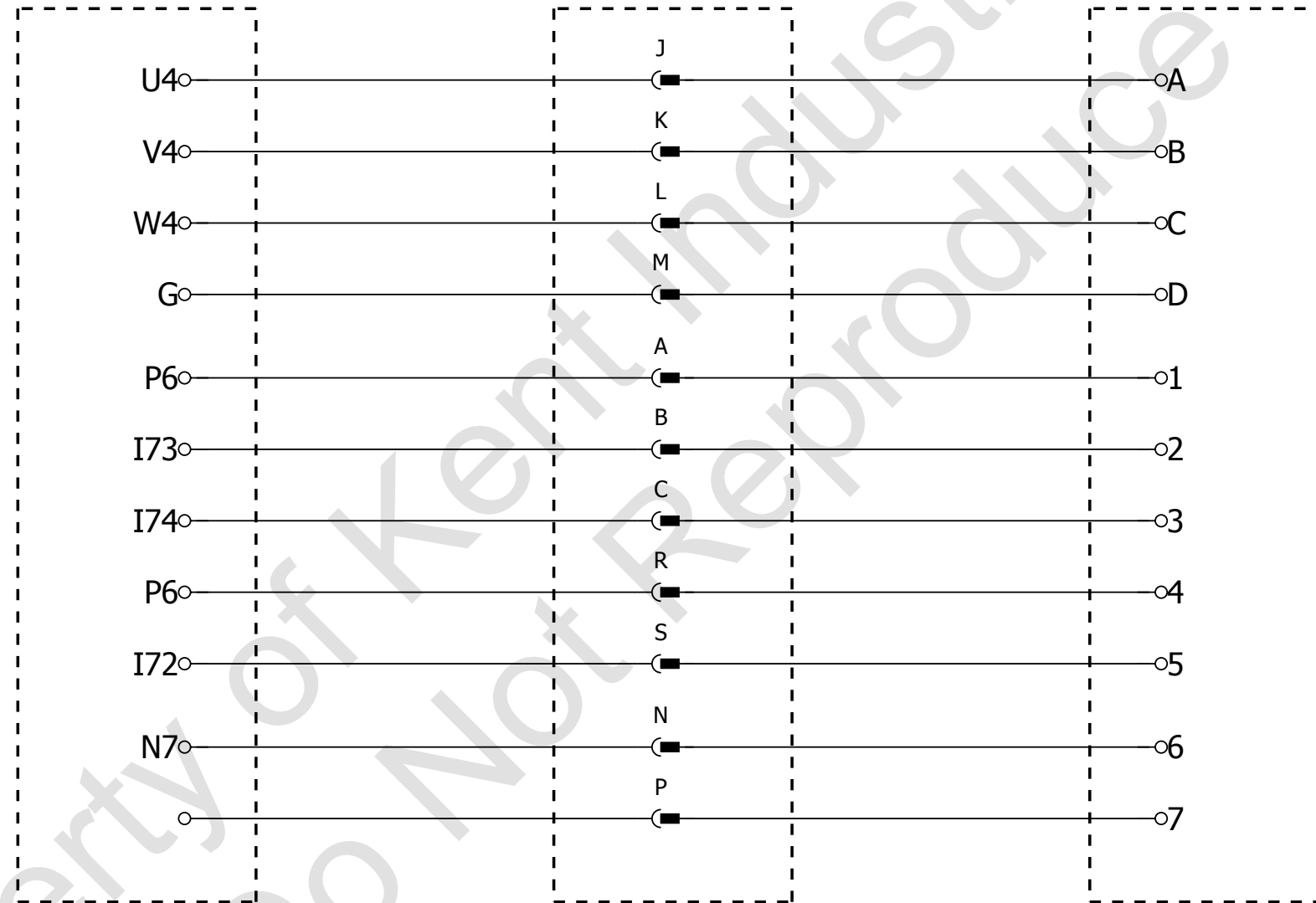

Property of Kent Industrial USA
Do Not Reproduce

Machine Model	Designaion Standard	Title Paeg	BARON-MAX	=
	FAGOR 8055I CNC	4-AXIS MOTOR	Date: 2012/4/26	+
			Ref:	Page 29
				Page 30

0

1

2

3

4

5

A

B

C

D

4-AXIS ENCODER HD.SUB-D.M26
TYPE MALE CONNECTOR

3102A-20-29S
FEMALE CONNECTOR

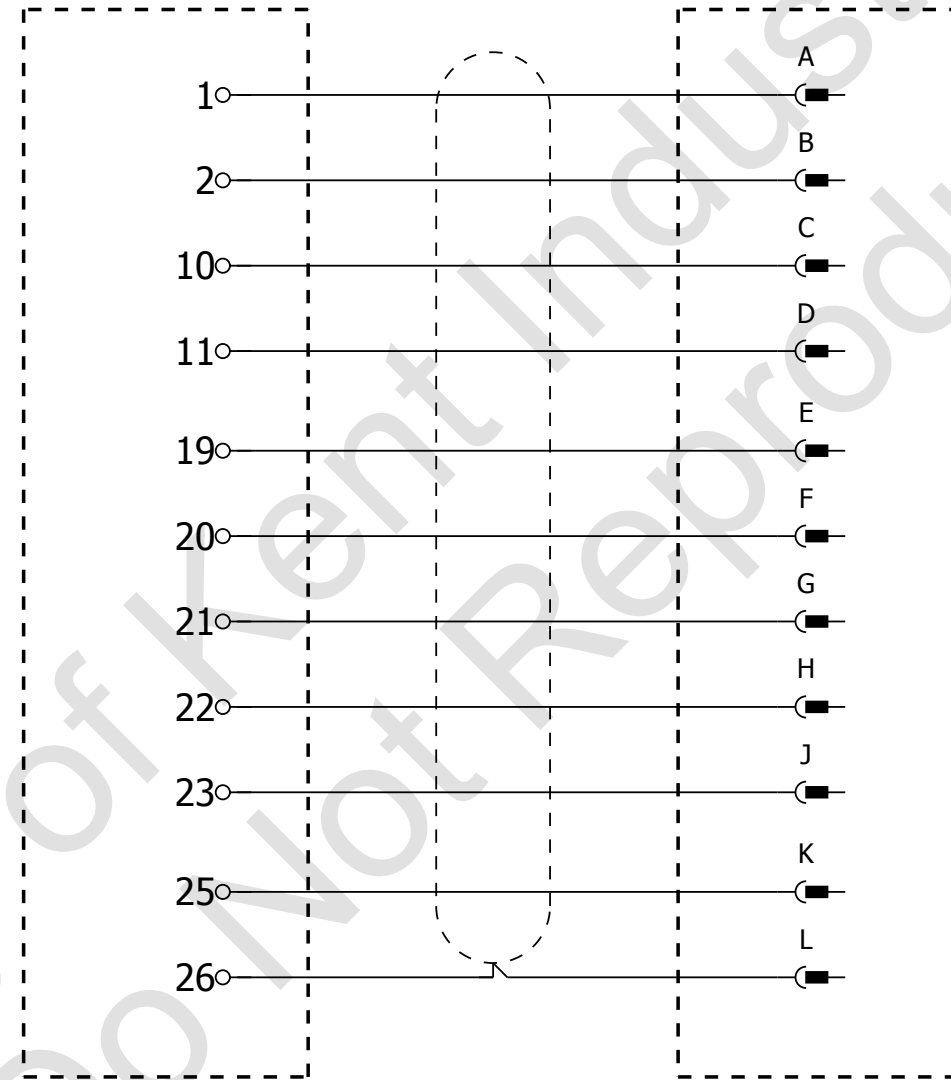

TO DRIVER X4

29

Machine Model	Designaion Standard	Title Paeg	BARON-MAX	=
	FAGOR 8055I CNC	4-AXIS-ENCODER	Date: 2012/4/26	+
			Ref:	Page 30
				Page 30